

**U.S. ARMY MEDICAL DEPARTMENT CENTER AND SCHOOL
FORT SAM HOUSTON, TEXAS 78234-6100**

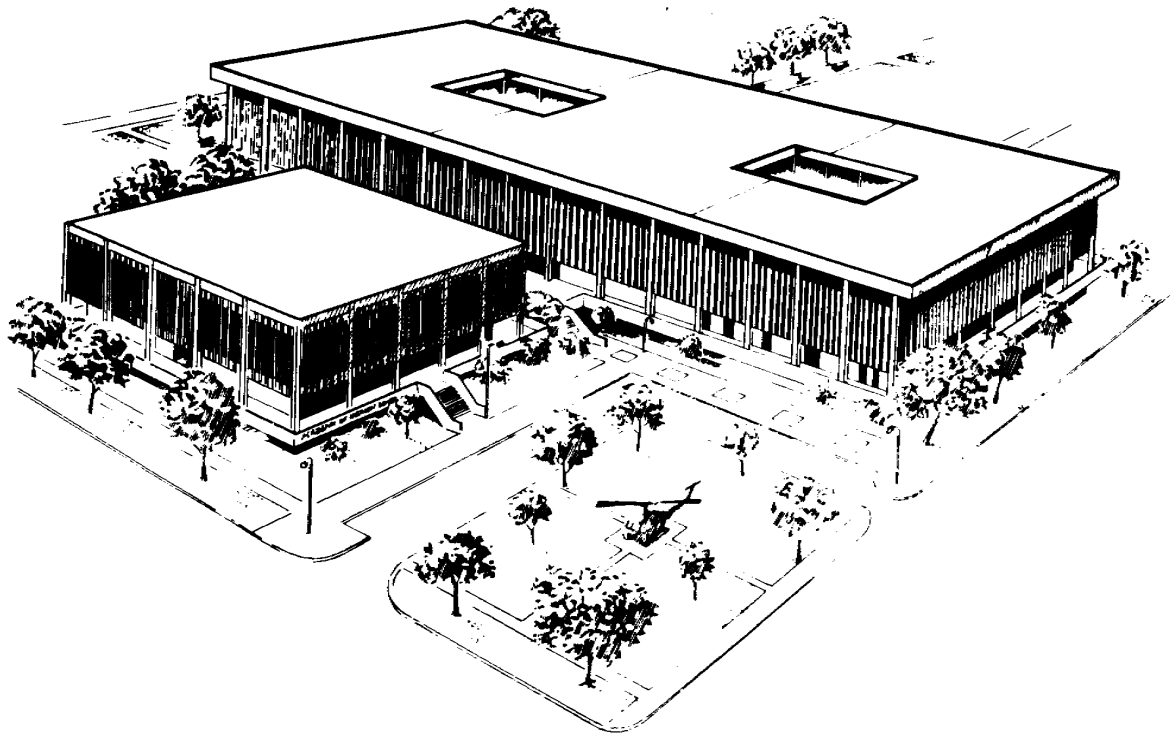

NURSING CARE OF THE SURGICAL PATIENT

SUBCOURSE MD0915

EDITION 100

DEVELOPMENT

This subcourse is approved for resident and correspondence course instruction. It reflects the current thought of the Academy of Health Sciences and conforms to printed Department of the Army doctrine as closely as currently possible. Development and progress render such doctrine continuously subject to change.

When used in this publication, words such as "he," "him," "his," and "men" are intended to include both the masculine and feminine genders, unless specifically stated otherwise or when obvious in context.

The education specialist responsible for development of this edition was Mr. Joe McNaul, AUTOVON 471-6346 or area code 210-221-6346, Academy of Health Sciences, ATTN: MCCS-HNP, Fort Sam Houston, Texas 78234-6100.

The subject matter expert responsible for content accuracy of this edition was MAJ Christine D. Johnson, Nursing Science Division, AUTOVON 471-3086 or area code (210) 221-3086; Director, Phase I, M6 Branch, Academy of Health Sciences, ATTN: MCCS-HNP, Fort Sam Houston, Texas 78234-6100.

ADMINISTRATION

Students who desire credit hours for this correspondence subcourse must meet eligibility requirements and must enroll through the Nonresident Instruction Branch of the U.S. Army Medical Department Center and School (AMEDDC&S).

Application for enrollment should be made at the Internet website: <http://www.atrrs.army.mil>. You can access the course catalog in the upper right corner. Enter School Code 555 for medical correspondence courses. Copy down the course number and title. To apply for enrollment, return to the main ATRRS screen and scroll down the right side for ATRRS Channels. Click on SELF DEVELOPMENT to open the application and then follow the on screen instructions.

In general, eligible personnel include enlisted personnel of all components of the U.S. Army who hold an AMEDD MOS or MOS 18D. Officer personnel, members of other branches of the Armed Forces, and civilian employees will be considered eligible based upon their AOC, NEC, AFSC or Job Series which will verify job relevance. Applicants who wish to be considered for a waiver should submit justification to the Nonresident Instruction Branch at e-mail address: accp@amedd.army.mil.

For comments or questions regarding enrollment, student records, or shipments, contact the Nonresident Instruction Branch at DSN 471-5877, commercial (210) 221-5877, toll-free 1-800-344-2380; fax: 210-221-4012 or DSN 471-4012, e-mail accp@amedd.army.mil, or write to:

NONRESIDENT INSTRUCTION BRANCH
AMEDDC&S
ATTN: MCCS-HSN
2105 11TH STREET SUITE 4191
FORT SAM HOUSTON TX 78234-5064

TABLE OF CONTENTS

<u>Lesson</u>	<u>Paragraphs</u>
INTRODUCTION	
1 PREOPERATIVE CARE OF THE SURGICAL PATIENT	1-1--1-7
Exercises	
2 OPERATING ROOM CARE OF THE SURGICAL PATIENT ..	2-1--2-9
Section I. INTRODUCTION	2-1--2-2
Section II. SURGICAL TEAM	2-3--2-4
Section III. THE ANESTHETIC AGENT	2-5--2-7
Section IV. REASONS FOR SURGERY	2-8--2-9
Exercises	
3 RECOVERY ROOM CARE OF THE SURGICAL PATIENT ...	3-1--3-7
Section I. INTRODUCTION	3-1--3-3
Section II. COMPLICATIONS IN THE RECOVERY ROOM	3-4--3-5
Section III. SUCTIONING THE PATIENT IN THE RECOVERY ROOM	3-6--3-7
Exercises	
4 POSTOPERATIVE CARE OF THE SURGICAL PATIENT ...	4-1--4-19
Section I. INTRODUCTION	4-1--4-2
Section II. EFFECTS OF ANESTHESIA ON MAJOR BODY SYSTEMS	4-3--4-7
Section III. EFFECTS OF SURGERY ON THE INTEGUMENTARY SYSTEM	4-8--4-12
Section IV. NURSING IMPLICATIONS BY BODY SYSTEMS OF A POSTOPERATIVE PATIENT	4-13--4-17
Section V. GENERAL NURSING IMPLICATIONS OF THE POSTOPERATIVE PATIENT ...	4-18--4-19
Exercises	

**CORRESPONDENCE COURSE OF
THE U.S. ARMY MEDICAL DEPARTMENT CENTER AND SCHOOL**

SUBCOURSE MD0915

NURSING CARE OF THE SURGICAL PATIENT

INTRODUCTION

Surgery encompasses all elements in the scientific care of surgical patients. The operation is the focal point for these patients. It is imperative that the patient comes to the operating room (OR) optimally prepared physically and emotionally before performance of an operative procedure. The persons concerned with and/or contributing to surgical patient care are many. The practical nurse shares a special experience with the patient at this time of great stress and need in his life. Their relationship encompasses feelings, attitudes, and behavior approaches. The nurse's first objective is to promote and establish a meaningful, therapeutic relationship, enabling the provision of individualized care. He, then, is to provide the perioperative nursing care that is required for the safest possible care of the patient and production of a favorable surgical outcome.

Subcourse Components:

This subcourse consists of four lessons and an examination. The lessons are:

Lesson 1, Preoperative Care of the Surgical Patient.

Lesson 2, Operating Room Care of the Surgical Patient.

Lesson 3, Recovery Room Care of the Surgical Patient.

Lesson 4, Postoperative Care of the Surgical Patient.

Credit Awarded:

Upon successful completion of this subcourse, you will be awarded 10 credit hours.

Materials Furnished:

Materials provided include this booklet, an examination answer sheet, and an envelope. Answer sheets are not provided for individual lessons in this subcourse because you are to grade your own lessons. Exercises and solutions for all lessons are contained in this booklet. *You must furnish a #2 pencil.*

Procedures for Subcourse Completion:

You are encouraged to complete the subcourse lesson by lesson. When you have completed all of the lessons to your satisfaction, fill out the examination answer sheet and mail it to the U.S. Army Medical Department Center and School along with the Student Comment Sheet in the envelope provided. *Be sure that your name, rank, social security number, and return address are on all correspondence sent to the U.S. Army Medical Department Center and School.* You will be notified by return mail of the examination results. Your grade on the exam will be your rating for the subcourse.

Study Suggestions:

Here are suggestions that may be helpful to you in completing this subcourse:

- Read and study each lesson carefully.
- Complete the subcourse lesson by lesson. After completing each lesson, work the exercises at the end of the lesson, marking your answers in this booklet.
- After completing each set of lesson exercises, compare your answers with those on the solution sheet, which follows the exercises. If you have answered an exercise incorrectly, check the reference cited after the answer on the solution sheet to determine why your response was not the correct one.
- As you successfully complete each lesson, go on to the next. When you have completed all of the lessons, complete the examination. Mark your answers in this booklet; then transfer your responses to the examination answer sheet using a #2 pencil.

Student Comment Sheet:

Be sure to provide us with your suggestions and criticisms by filling out the Student Comment Sheet (found at the back of this booklet) and returning it to us with your examination answer sheet. Please review this comment sheet before studying this subcourse. In this way, you will help us to improve the quality of this subcourse.

LESSON ASSIGNMENT

LESSON 1

Preoperative Care of the Surgical Patient.

TEXT ASSIGNMENT

Paragraphs 1-1 through 1-7.

LESSON OBJECTIVES

After completing this lesson, you should be able to:

- 1-1. Identify key terms related to preoperative patient care and medications.
- 1-2. Identify facts that are related to the surgical experience.
- 1-3. Identify principles related to teaching preoperative exercises.
- 1-4. Identify items found on DD Form 1924, Surgical Checklist.
- 1-5. Identify facts that are related to SF 522, Request For Administration of Anesthesia and For Performance of Operations and Other Procedures.
- 1-6. Identify nursing implications that are related to the preparation of a patient the night before surgery.
- 1-7. Identify nursing implications that are related to the personal hygiene care given to a patient the night before surgery.
- 1-8. Identify nursing implications that are related to the preparation of a patient the morning of surgery.

SUGGESTION

After completing the assignment, complete the exercises at the end of the lesson. These exercises will help you to achieve the lesson objectives.

LESSON 1

PREOPERATIVE CARE OF THE SURGICAL PATIENT

1-1. GENERAL

The patient who consents to have surgery, particularly surgery that requires a general anesthetic, renders himself dependent on the knowledge, skill, and integrity of the health care team. In accepting this trust, the health care team members have an obligation to make the patient's welfare their first consideration during the surgical experience. This lesson consists of your duties as a practical nurse to provide preoperative care for the surgical patient.

1-2. DEFINITIONS

a. **Anesthesia.** A partial or complete loss of sensation, with or without loss of consciousness, as a result of a disease, an injury, or administration of a drug.

b. **Cyanosis.** A Greek word for the slightly bluish-gray or purple discoloration of the skin due to a deficiency of oxygen and an excess of carbon dioxide in the blood. (Oxygen in the blood makes it look red and gives the skin a pink tone.)

c. **Narcotics.** A group of drugs producing stupor, sleep, or complete unconsciousness; used to allay pain. Narcotics are regulated by federal laws.

d. **NPO.** Nothing by mouth (Latin, nulli per os).

e. **Perioperative Period.** The period extending from the time of hospitalization for surgery to the time of discharge (see Figure 1-1).

f. **Preoperative Phase.** That phase of the perioperative period during which the nurse admits the patient to the surgical unit and helps the individual prepare physically and emotionally for the operation. Refer to Figure 1-1.

g. **Prosthesis.** An artificial organ or part; for example, an artificial limb, eyeglasses, or dentures.

h. **Thrombophlebitis.** Inflammation of a vein associated with thrombus formation.

i. **Thrombus.** A blood clot.

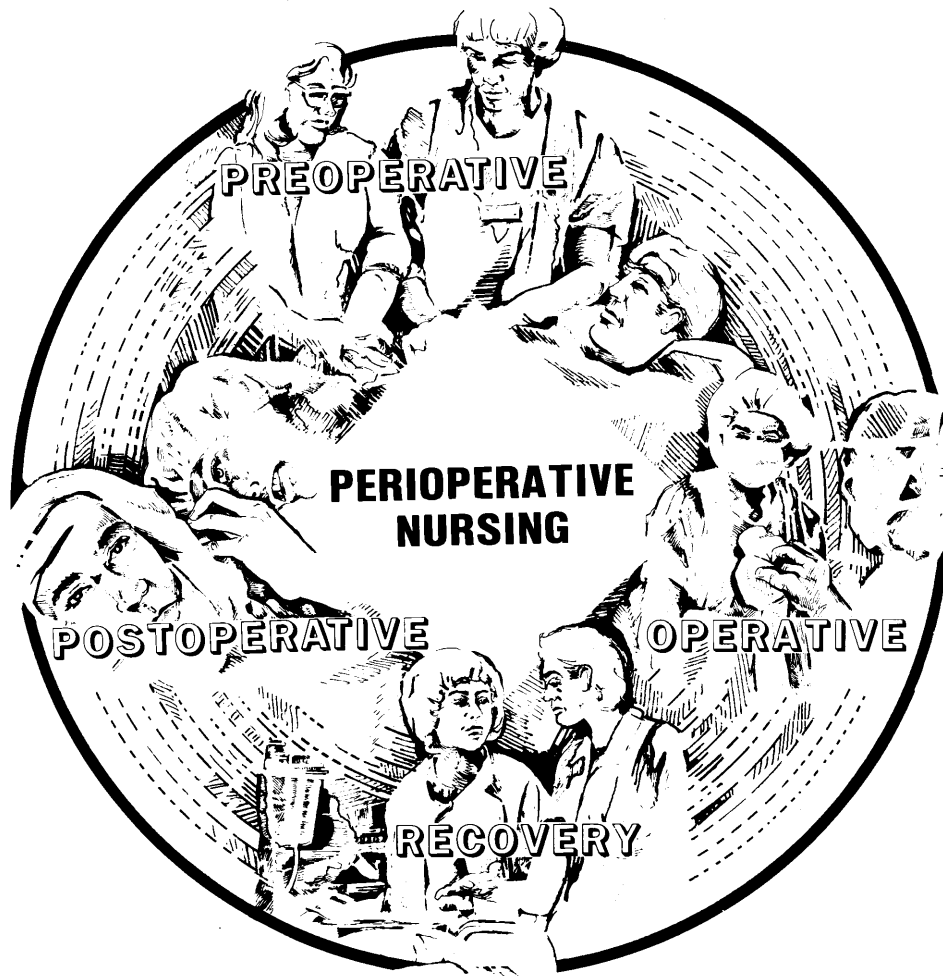

Figure 1-1. Perioperative nursing.

NOTE: Figure 1-1 shows teaching the patient and spouse during the preoperative phase; nurse handing sponge to surgeon in the operative phase; patient being observed and monitored during the recovery phase; and nurse checking patient's bandage during the postoperative phase.

1-3. PREOPERATIVE PHASE

Although the physician is responsible for explaining the surgical procedure to the patient, the patient may ask the nurse questions about the surgery. There may be specific learning needs about the surgery that the patient and support persons should know. A nursing care plan and a teaching plan should be carried out. During this phase, emphasis is placed on:

- a. Assessing and correcting physiological and psychological problems that may increase surgical risk.

b. Giving the patient and significant others complete learning and teaching guidelines regarding the surgery.

c. Instructing and demonstrating exercises that will benefit the patient postoperatively.

d. Planning for discharge and any projected changes in lifestyle due to the surgery.

1-4. SURGICAL EXPERIENCE

Surgery is an important event in any individual's life. It represents a serious decision involving the patient's body and his health. It also produces physical and psychological stress on the body relative to the extent of the surgery and injury to the tissue involved. The patient must understand what is proposed, understand all the risks, and give his consent.

a. **Physical Stress.** Surgery produces actual physical damage to tissues of the body.

(1) An incision is a cutting of the skin and other tissues. The internal organs and tissues of the body are handled by the surgeon and assistants. This could lead to bruising of tissues, injury to tissues, or inflammation of tissues that could result in pain after the anesthesia wears off.

(2) Incisions through the skin and mucous membranes penetrate the protective barriers of the internal organs. This puts a patient at risk of microorganisms entering the body and causing infection. Surgery requires strict attention to aseptic technique, use of sterile materials, and thorough disinfecting of the skin around the operative site.

(3) The effects of anesthesia and other medications tend to last well into the postoperative recovery period. These drugs could have a depressant effect on the body; they decrease pain and reduce awareness of one's surroundings. The effect on the body systems is to slow the systems down and make them hypoactive.

b. **Psychological Stress.** The physical stress of surgery is greatly enhanced by the psychological stress of anxiety and worry, which uses up energy that is needed for healing of tissues in the postoperative period. When surgery is needed, one's deepest and worst fears are often felt. A preoperative patient may experience a number of fears. However, the following fears are common among surgical patients:

(1) Loss of part of the body.

(2) Unconsciousness and the inability to know or control what is happening.

- (3) Pain.
- (4) Death.
- (5) Separation from family.
- (6) Effects of surgery on home and employment.
- (7) Exposure of his body to strangers.

c. **Managing Preoperative Fears.** Psychological preparation of the patient before surgery can not be overlooked. Along with other members of the health care team, the practical nurse must show warmth, sensitivity, and caring to the patient. Each patient may express his fears in different ways. You may find that a patient may not talk about his fears. He may be quiet and withdrawn, cry, or talk constantly. Some patients may prefer pacing, be extremely cheerful, or, on the other hand, exhibit unusual behavior. You, as a practical nurse, must recognize these fears and deal with them properly. You can help to manage preoperative fears by:

- (1) Providing an opportunity for the patient to describe his reactions and feelings in the stressful situation.
- (2) Providing or reinforcing patient teaching.
- (3) Arranging for a clergy to visit if the patient desires. (Religious faith can be a strong source of strength.)
- (4) Being truthful and honest when answering patient questions. If there are questions that you should not or are unable to answer, refer them to the Charge Nurse or physician.

1-5. PREOPERATIVE TEACHING PRINCIPLES

a. The value of preoperative instruction to the patient is very important. Each patient should be taught as an individual, in terms of his anxieties, need, and hope. Patients should be taught postoperative exercises they will be required to do and their role in preventing complications. The postoperative exercises include turning, deep breathing, coughing, and extremity movement.

(1) Turning. Turning in bed and early ambulation helps patients maintain blood circulation, stimulate respiratory functions, and decrease the stasis of gas in the intestines and resulting discomfort. Practice before surgery usually makes it easier for the patient to do it postoperatively. In some instances, the patient may need special aids, such as a pillow between the legs, to help maintain body alignment. See Figure 1-2.

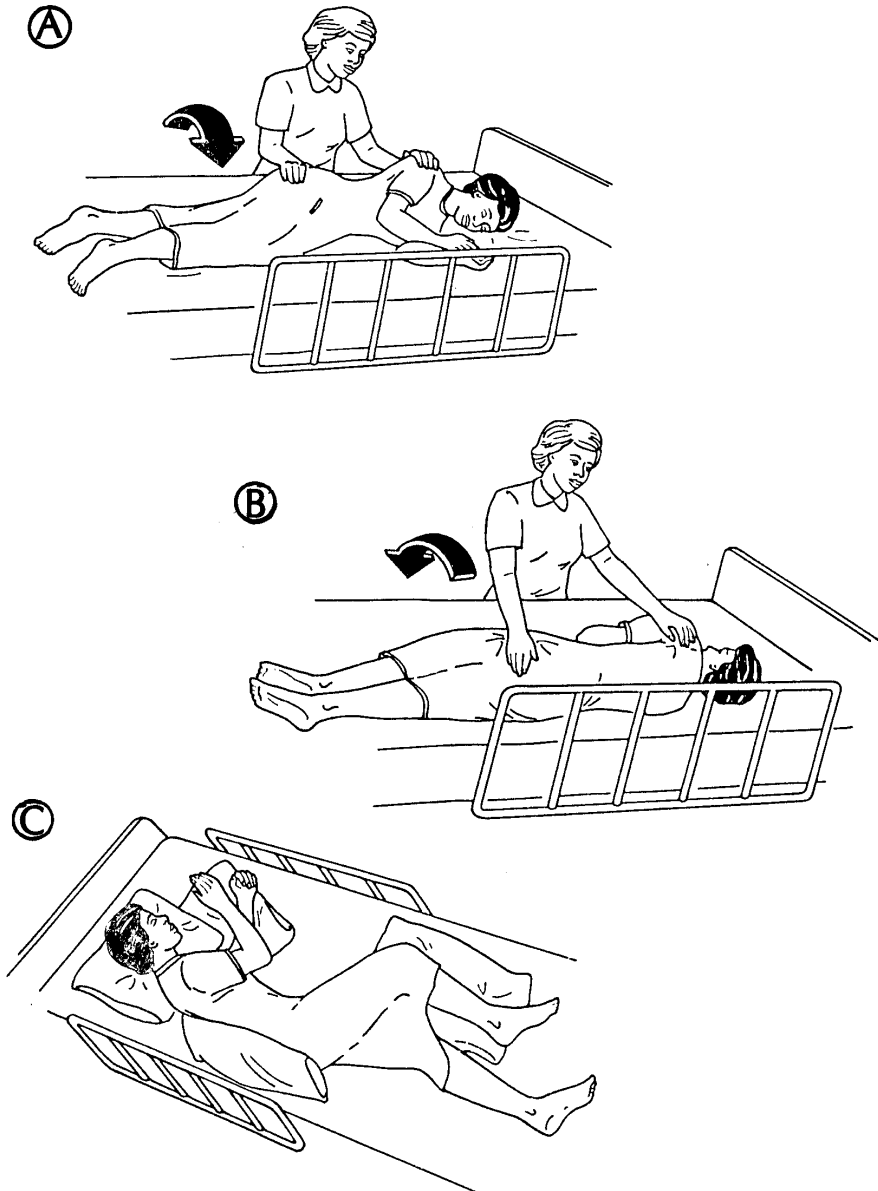

Figure 1-2. Turning techniques.

- A.** Patient turned away from the nurse with arms and legs crossed.
- B.** Patient turned toward the nurse with arms and legs crossed.
- C.** Patient on side in middle of bed with a pillow in front of the bottom leg with the top leg on the pillow in flexed position, a pillow against the back, a small pillow supports the arm and hand, pillow under head and shoulder.

(2) Deep breathing. Deep breathing helps prevent postoperative pneumonia and atelectasis (incomplete expansion of the lung or a portion of the lung). In deep breathing, the patient should inhale and exhale as much air as possible. You are to explain the procedure and its purpose to the patient. Instruct the patient to:

(a) Inhale slowly through the nose, distending the abdomen and exhaling slowly through pursed lips (see Figure 1-3).

(b) Deep breathe as often as possible, preferably 5 to 10 times every hour during the postoperative, immobilized period.

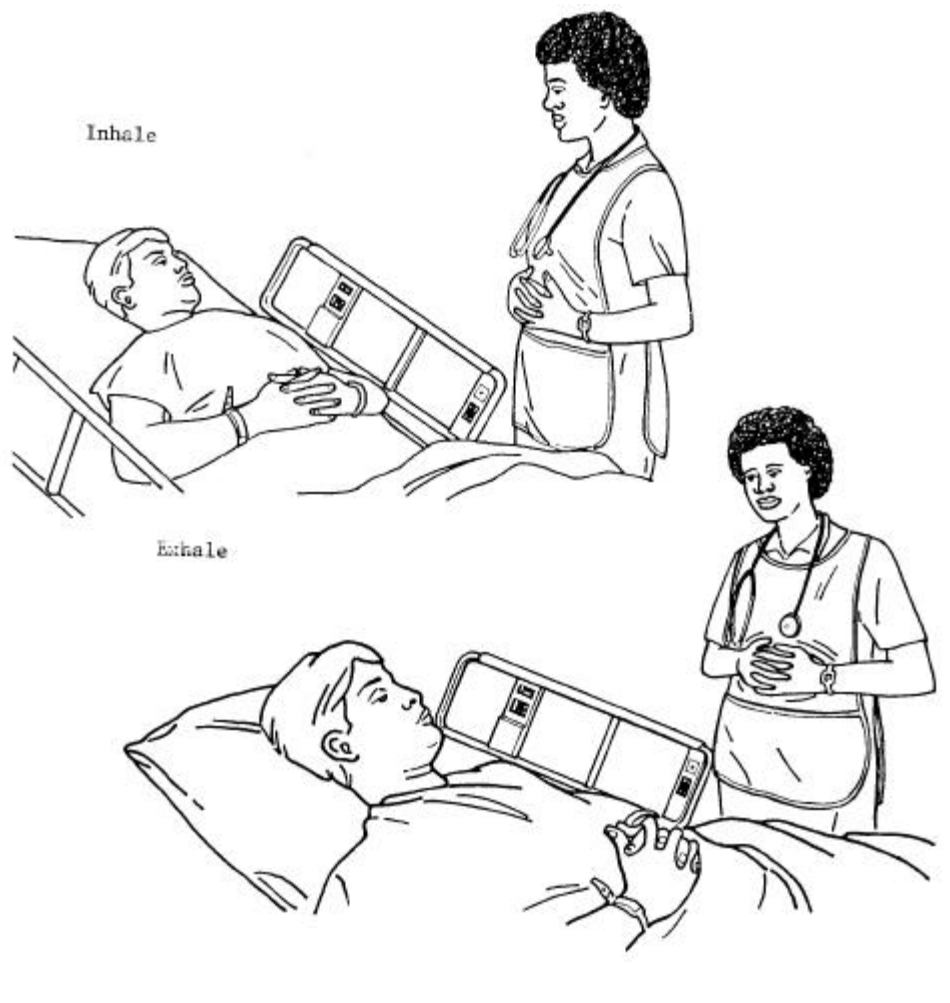

Figure 1-3. Deep breathing exercise.

(3) Coughing. Coughing is done to mobilize and expel respiratory system secretions which, because of the effects of anesthesia, tend to pool in the lungs and may cause pneumonia. The patient should be in a sitting or lying position. Instruct the patient to:

- (a) Lean forward slightly while sitting in bed.
- (b) Take a deep breath.
- (c) Inhale fully with the mouth slightly open.
- (d) Let out three to four sharp "hacks."
- (e) With mouth open, take in a deep breath and give one or two strong coughs.
- (f) Repeat steps (a) through (e) ten times, as tolerated.

NOTE: The above steps should be repeated every two hours during the postoperative phase or as prescribed.

(g) The patient may lace his fingers and hold them tightly across the incision before coughing. This is used as a splint to minimize pressure and helps to control pain when the patient is coughing. A small pillow or folded towel may be used in place of laced fingers. See Figure 1-4.

NOTE: Encourage the patient to perform deep breathing exercises **before** coughing. This stimulates cough reflex.

(4) Extremity exercises. These exercises help to prevent circulatory problems, such as thrombophlebitis, by facilitating venous return to the heart. It also decreases postoperative "gas pains." See Figure 1-5 for legs and feet exercises. The patient should:

- (a) Flex and extend each joint, particularly the hip, knee, and ankle joints, keeping the lower back flat as the leg is lowered and straightened.
- (b) Move each foot in a circular motion.

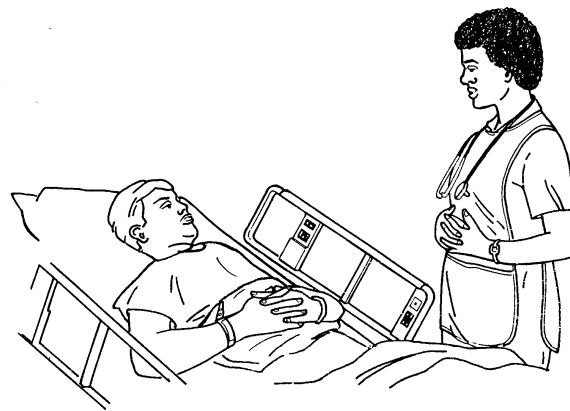
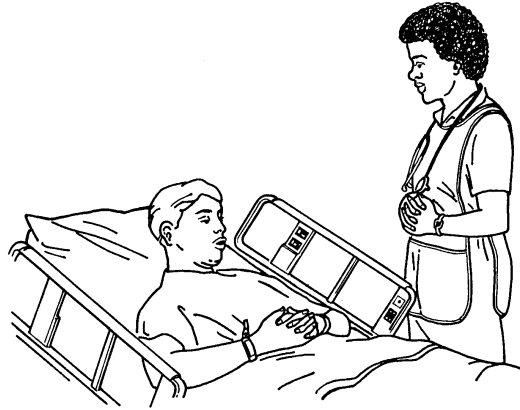

Figure 1-4. Coughing exercise.

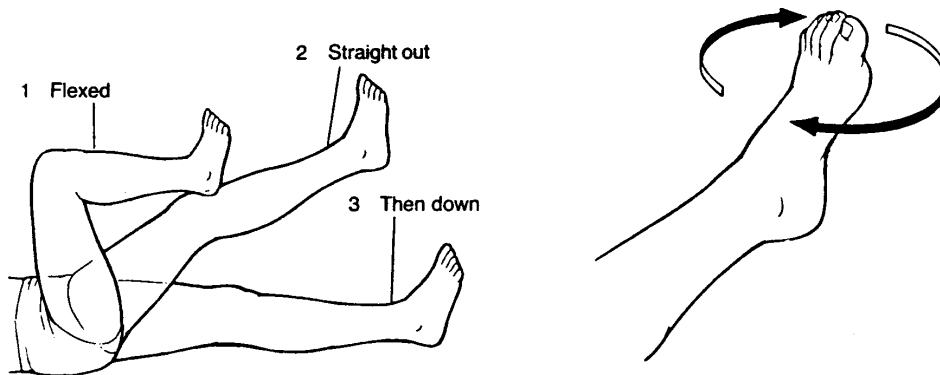

Figure 1-5. Legs and feet exercises.

b. **Time of Instruction.** The best time to teach patients is relatively close to the time of surgery, which is usually the afternoon or evening before the surgery.

(1) If instruction is given several days in advance, the patient may forget.

(2) If instruction is given just before surgery, the patient may be too apprehensive to listen or too heavily sedated to comprehend.

(3) If the patient is undergoing minor surgery (one-day or same-day surgery), the patient may receive preoperative instructions several hours before surgery.

1-6. NURSING IMPLICATIONS FOR PREPARING A PATIENT FOR SURGERY

a. **Patient's Chart.** The preoperative patient's chart must be complete before the patient leaves the nursing unit. It will contain all the information that may be needed by the physicians and nurses in the operating room or later in the recovery room. The chart should be prepared by using DD Form 1924, Surgical Checklist (see Figure 1-6). DD Form 1924 is attached to the front of the patient's chart for easy access by all involved hospital staff. It contains the following information:

(1) Patient's identification.

(2) Checklist for pertinent health records.

(3) Block for recording the most current set of vital signs taken prior to preoperative medications.

(4) Block to indicate allergies.

(5) Block to document all preoperative nursing measures.

(6) Block to document comments. Any special comment that indicates something very special about this particular patient will go in this block (hard of hearing, removal of a prosthesis, etc.).

(7) Block for signature of release when all actions are completed.

b. **Procedures Used to Prepare the Patient's Chart.** You will use DD Form 1924, Surgical Checklist, as a checklist to assemble the patient's chart and to document compliance as each step is completed.

(1) DD Form 1924. Enter the patient's identifying information in the patient's identification block. This information may be entered by using the addressograph plate or by hand. If you enter the information by hand, enter the patient's ward, room, and bed in the appropriate block.

		SURGICAL CHECK LIST	
		WARD/ROOM/BED	
PATIENT'S IDENTIFICATION		<i>INSTRUCTIONS: Initial or mark N/A if not applicable</i>	
CLINICAL RECORDS		PRE - OP COUNSELING TO PATIENT	
SF 515 (2) - TISSUE EXAMINATION		PRE - OP PREP	
SF 516 (3) - OPERATION REPORT		A.M. CARE	
SF 517 (2) - ANESTHESIA		VALUABLES AND JEWELRY REMOVED <i>(Wedding Band may be taped in place)</i>	
SF 518 (3) - BLOOD TRANSFUSION _____ UNITS		HAIRPINS, LIPSTICK, NAILPOLISH REMOVED	
SF 522 - OPERATIVE PERMIT <i>(Signed)</i>		DENTURES BRIDGE REMOVED	
HISTORY AND PHYSICAL		CONTACT LENSES CLASS EYE GLASSES, HAIRPIECE, PROSTHESIS REMOVED	
SF 511 - T. P. R. GRAPHIC		VOIDED <i>(Specify time)</i>	
NURSES NOTES & DOCTORS ORDERS		ENEMA <i>(If Ordered)</i>	
X-RAY <i>(ONLY the required)</i>		ID BAND ON ARM	
REPORTS		INPATIENT IDENT PLATE <i>(In envelope)</i>	
FILMS			
LABORATORY REPORTS <i>(ONLY the required)</i>			
HEMATOLOGY		PRE - OP MEDICATION <i>(Specify kind and time administered)</i>	
URINE			
EKG			
TPR AND BP <i>(Prior to pre-op medication)</i>	CATHETER IN PLACE <input type="checkbox"/> YES <input type="checkbox"/> NO <input type="checkbox"/> CLAMPED <input type="checkbox"/> TO DRAINAGE		
KNOWN ALLERGIES			
COMMENTS			
SIGNATURE OF NURSE RELEASING PATIENT TO OPERATING ROOM			

FOR INPATIENT IDENTIFICATION PLATE

DD FORM 1924
1 SEP 73

REPLACES DA FORM 3629, 1 JUL 72, AND AF FORM 534, SEP 70,
WHICH WILL BE USED UNTIL EXHAUSTED

Figure 1-6. DD Form 1924, Surgical Checklist.

(2) Patient's chart. Ensure that all required forms are included, complete as necessary, and in order dictated by local policy. Document compliance or insert form(s) as necessary.

(a) Place your initials in the box to indicate that the form is in the chart and completed.

(b) If forms are missing or incomplete, notify the Charge Nurse or physician as indicated.

(c) Required forms are:

1 SF 515, Tissue Examination -- 2 copies.

2 SF 516, Operation Report -- 3 copies.

3 SF 517, Anesthesia -- 2 copies.

4 SF 518, Blood or Blood Component Transfusion -- 3 copies.

5 SF 522, Request for Administration of Anesthesia and for Performance of Operations and Other Procedures (see Figure 1-7.) This is the legal document that satisfies the requirement of informed consent.

a It must be signed by the physician and anesthesiologist to indicate that all risks of surgery and anesthesia have been fully explained to the patient.

b The preoperative patient must sign the form in the presence of a witness to consent for a surgical procedure.

c The witness must NOT be anyone on the surgical team.

d The date and time that the patient signed must be written on the form.

e Minors (patients under legal age) cannot sign for themselves; it must be signed by a parent or legal guardian.

NOTE: Legal age is established on a state-by-state basis.

f Legal consents must be signed PRIOR to the preoperative administration of narcotics or any type of mind altering medication, or the form is not legally binding.

MEDICAL RECORD

REQUEST FOR ADMINISTRATION OF ANESTHESIA AND FOR PERFORMANCE OF OPERATIONS AND OTHER PROCEDURES

A. IDENTIFICATION

1. OPERATION OR PROCEDURE

B. STATEMENT OF REQUEST

1. The nature and purpose of the operation or procedure, possible alternative methods of treatment, the risks involved, and the possibility of complications have been fully explained to me. I acknowledge that no guarantees have been made to me concerning the results of the operation or procedure. I understand the nature of the operation or procedure to be _____

which is to be performed by or under the direction of Dr. _____

2. I request the performance of the above-named operation or procedure and of such additional operations or procedures as are found to be necessary or desirable, in the judgment of the professional staff of the below-named medical facility, during the course of the above-named operation or procedure.

3. I request the administration of such anesthesia as may be considered necessary or advisable in the judgment of the professional staff of the below-named medical facility.

4. Exceptions to surgery or anesthesia, if any, are: _____

5. I request the disposal by authorities of the below-named medical facility of any tissues or parts which it may be necessary to remove.

6. I understand that photographs and movies may be taken of this operation, and that they may be viewed by various personnel undergoing training or indoctrination at this or other facilities. I consent to the taking of such pictures and observation of the operation by authorized personnel, subject to the following conditions:

- a. The name of the patient and his/her family is not used to identify said pictures.
b. Said pictures be used only for purposes of medical/dental study or research.

C. SIGNATURES

1. COUNSELING PHYSICIAN/DENTIST: I have counseled this patient as to the nature of the proposed procedure(s), attendant risks involved, and expected results, as described above.

(Signature of Counseling Physician/Dentist)

2. PATIENT: I understand the nature of the proposed procedure(s), attendant risks involved, and expected results, as described above, and hereby request such procedure(s) be performed.

(Signature of Witness, excluding members of operating team)

(Signature of Patient)

(Date and Time)

3. SPONSOR OR GUARDIAN: (When patient is a minor or unable to give consent) I, _____ sponsor/guardian of _____ understand the nature of the proposed procedure(s), attendant risks involved, and expected results, as described above, and hereby request such procedure(s) be performed.

(Signature of Witness, excluding members of operating team)

(Signature of Sponsor/Legal Guardian)

(Date and Time)

PATIENT'S IDENTIFICATION (For typed or written entries give Name—last, first, middle, grade, date; hospital or medical facility)

REGISTER NO.

WARD NO.

STANDARD FORM 522 (Rev. 10-76)
General Services Administration &
Interagency Comm. on Medical Records
FPMR 101-11.806-8
522-109

GPO : 1981 O - 361-526 (7362)

NSN 7540-00-634-4165

Figure 1-7. SF 522, Request for Administration of Anesthesia and for Performance of Operations and Other Procedures.

6 History and Physical, SF 511 (T.P.R. Graphic), SF 510 (Nursing Notes), and Doctor's Orders. Check the patient's health record for inclusion of these forms and document compliance.

a Each form will be checked for date, signature, and accurate transcription.

b Stamp and insert new forms for use during surgical experience, if needed,

(3) Acquire required x-ray reports and films as necessary, insert reports into patient's chart, and document compliance.

(a) Ensure x-rays have been taken.

(b) Check for x-ray results in health records.

(c) If the results are not on the record, call x-ray for results and write report in comments section. Make an attempt to locate written x-ray report and films.

(d) Notify the Charge Nurse or physician immediately of previously unreported abnormal x-ray findings.

(4) Acquire laboratory reports as required, insert reports into the patient's chart, and document compliance.

(a) Ensure ordered lab work has been done.

(b) Check for laboratory results on health records.

(c) If the laboratory results are not in the record, call the laboratory for results and write the report in the "comments" block. Make an attempt to locate written lab reports to place in the patient's chart.

(d) If laboratory reports indicate abnormal values which may not have been known by the physician and which could influence surgery, notify the Charge Nurse or physician immediately.

(5) Acquire EKG report as required, insert the report into the patient's chart, and document compliance.

(a) Ensure EKG was completed for all patients over 40 years of age and others as ordered.

(b) Check with appropriate department (Internal Medicine or Cardiology) for EKG readings if not in record.

(c) If the results are not on the health record, call the department for the report and place the information in the "comments" block. Make an attempt to locate the written report to place in the health record.

(d) Notify the Charge Nurse or physician immediately of previously unreported abnormal EKG results.

c. **Final Preparation of the Preoperative Patient.** Document compliance on DD Form 1924 and on SF 510, Nursing Notes.

(1) Preoperative care. Implement doctor's orders for preoperative care.

(a) Administer an enema the night before surgery, if ordered. An enema is used to cleanse the colon of fecal material, thus reducing the possibility of wound contamination during surgery.

(b) Ensure that the operative site skin prep is done. An operating room technician or other designated person will clean and shave the area surrounding the side of the planned incision(s).

1 The skin prep is done to make the skin as free of microorganisms as possible, thus decreasing the possibility of microorganisms entering the wound from the skin surface during surgery.

2 A wide area of skin around the site of the incision is shaved and cleansed to further reduce the possibility of infection.

(2) Personal hygiene. Assist the patient with personal hygiene and related care.

(a) Bathe or shower. This is done to remove excess body dirt and oils. It gives the patient a sense of relaxation. Depending upon the extent of surgery, it may be several days before a patient may take a "real bath."

(b) Shampoo hair. This is also done for the same reasons as in the previous paragraph.

(c) Remove nail polish and make-up. During surgery, numerous areas must be observed carefully for evidence of cyanosis to include the face, lips, and nail beds. Make-up and nail polish hide true coloration.

(3) Mouth care. All preoperative patients should have thorough mouth care before surgery. A clean mouth makes the patient more comfortable and prevents accidental aspiration of food particles. Chewing gum must be removed before the patient goes to the operating room.

(4) Attire. Give the patient a clean hospital gown. The wearing of his own gown or pajamas to surgery is not permitted because of potential loss or damage.

(5) Prostheses. Ask the patient to remove his dentures, contact lenses, and artificial limbs. Be sure to place all items in a container labeled with the patient's name and room number. Take extra care not to break or loose patient's prostheses. If possible, send the prostheses home with a relative.

(6) Jewelry. Jewelry should be removed for safekeeping. Do NOT store in bedside stand -- give the jewelry to a relative. The patient may wear a wedding band to surgery secured with tape or gauze wrapping. Do not secure it so tightly as to impair circulation.

(7) Food and fluids. Follow the doctor's orders for type of diet preoperatively. Usually, the patient will be NPO from midnight on. Remove the patient's water pitcher. Place an NPO sign outside patient's room (see Figure 1-8). Mark the diet roster.

(8) Offer emotional support. Answer questions concerning surgery. Provide explanation of each preoperative nursing measure. Ask the patient about spiritual needs. Provide family members with information concerning their role the morning of surgery, waiting room location, postoperative visit by surgeon, rational for stay in recovery room, and presence of any special tubes or machines attached to their loved one.

(9) Sedative. Administer the patient a sedative for a good night's sleep, if ordered.

d. **Communication**. Good communication between all members of the health care team will ensure that the patient is well prepared and ready to undergo surgery. All shifts and nursing personnel must be an active participant in the preoperative phase of the surgical patient.

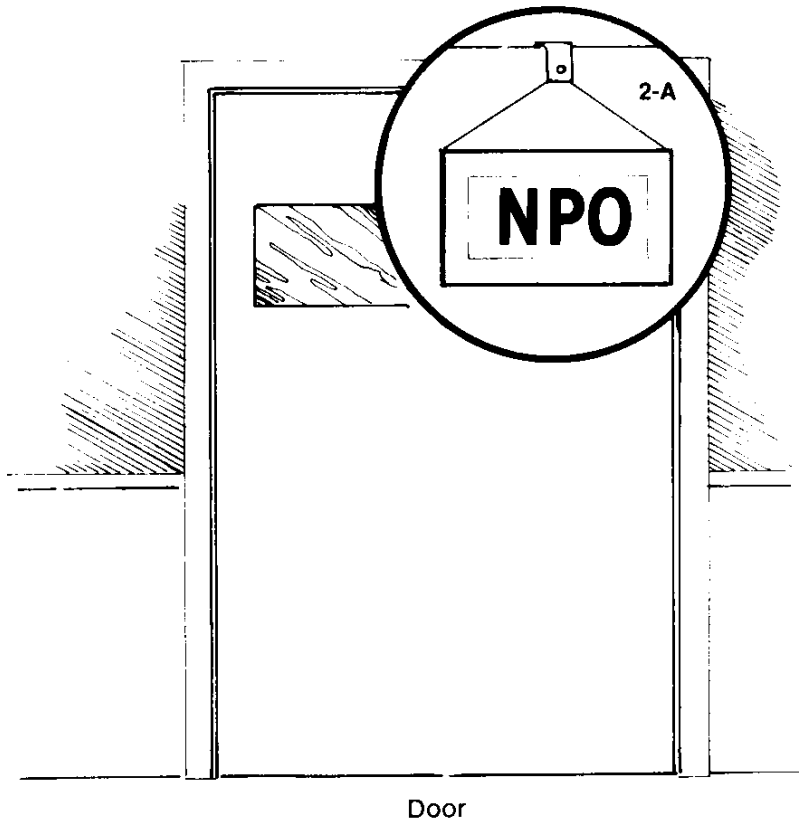

Figure 1-8. Typical NPO sign.

1-7. THE MORNING OF SURGERY

- a. Awaken the patient early enough so that he may:
 - (1) Perform morning care.
 - (2) Complete last-minute personal measures.
 - (3) Remove nightclothes.
 - (4) Visit with family.
- b. Take and record vital signs.
- c. Recheck accuracy of DD Form 1924.
- d. Administer preoperative medication if ordered. This medicine:

- (1) Enhances the effectiveness of anesthesia.
 - (2) Decreases the side effects of nausea/vomiting from anesthesia.
 - (3) Produces anti-anxiety.
 - (4) Dries up secretions.
- e. Provide for the patient's security by placing side rails in the up position and by placing a call bell within the patient's reach once preoperative medication is given.
- f. Assist the operating room technician to position the patient on the OR litter and make the patient comfortable.
- g. "Sign out" the patient on SF 510, Nursing Notes, to include:
- (1) Date.
 - (2) Time.
 - (3) Event.
 - (4) Status of patient.
- h. "Sign off" in the appropriate block on DD Form 1924, Surgical Checklist.

Continue with Exercises

EXERCISES, LESSON 1

INSTRUCTIONS: Answer the following exercises by marking the letter response that best answers the question or best completes the incomplete statement or by writing the answer in the space provided.

After you have completed all the exercises, turn to "Solutions to Exercises" at the end of the lesson and check your answers. For each exercise answered incorrectly, reread the material referenced with the solution.

1. An artificial part is known as a(n) _____.
2. _____ is a blood clot.
3. There is no difference between the perioperative period and the preoperative phase.
 - a. True.
 - b. False.
4. Surgery produces both _____ and _____ stress on the patient's body.
5. List five of the most common fears of surgery.

6. Preoperative instruction to the patient has no value.
 - a. True.
 - b. False.

7. _____ helps prevent postoperative pneumonia and atelectasis.

8. What should the patient (with his mouth opened) do before coughing?

9. What can be done to help prevent circulatory problems after surgery?

10. What is the name of DD Form 1924?

11. Which of the required forms in the patient's chart is required to have the preoperative patient's signature?

12. Your _____ on DD Form 1924 to indicate that the form or information is in the chart and completed.

13. Compliance with procedures for final preparation of the preoperative patient is documented on _____:

14. In "signing out" the preoperative patient in the Nursing Notes, you should include:

Check Your Answers on Next Page

SOLUTIONS TO EXERCISES, LESSON 1

1. Prosthesis (para 1-2g)
2. Thrombus (para 1-2i)
3. b (paras 1-2e, f)
4. Physical and psychological (paras 1-4a, b)
5. Any five of the following fears:
 - Pain.
 - Death.
 - Separation from family.
 - Loss of part of the body.
 - Exposure of his body to strangers.
 - Unconsciousness and the inability to know or control what is happening.
 - Effects of surgery on and employment. (para 1-4b)
6. b (para 1-5a)
7. Deep breathing (para 1-5a(2))
8. Take in a deep breath. (para 1-5a(3)(e))
9. Extremity exercise (para 1-5a(4))
10. Surgical Checklist (para 1-6a, fig 1-6)
11. SF 522, Request for Administration of Anesthesia and for Performance of Operations and Other Procedures (para 1-6b(2)(c)5b)
12. Initials (para 1-6b(2)(a))
13. DD Form 1924 and SF 510 (para 1-6c)
14. Date
Time
Event
Status of patient (para 1-7g)

End of Lesson 1

LESSON ASSIGNMENT

LESSON 2

Operating Room Care of the Surgical Patient.

TEXT ASSIGNMENT

Paragraphs 2-1 through 2-9.

LESSON OBJECTIVES

After completing this lesson, you should be able to:

- 2-1. Identify specific terms and definitions that are related to perioperative nursing.
- 2-2. Identify types of surgery/procedures.
- 2-3. Identify key members of the surgical team (surgeon, anesthesiologist, anesthetist, scrub nurse/technologist, and circulating nurse) and their functions.
- 2-4. Identify nine factors which effect the selection of an anesthetic agent.
- 2-5. Identify specific factors that are considered by the anesthesiologist/anesthetist when selecting an anesthetic agent.
- 2-6. Identify three major classifications of anesthetic agents (general, regional, and local) and their uses.
- 2-7. Identify descriptive statements referring to classifications of anesthesia.
- 2-8. Identify specific reasons why surgical procedures are performed.

SUGGESTION

After completing the assignment, complete the exercises at the end of the lesson. These exercises will help you to achieve the lesson objectives.

LESSON 2

OPERATING ROOM CARE OF THE SURGICAL PATIENT

Section I. INTRODUCTION

2-1. GENERAL

The patient undergoing surgery is the center of attention and all activity is focused on him in the operating room for the repair, correction, or relief of a physical ailment. Even though the patient may appear to be in good health and in for a minor operative procedure, he still may experience both physical and psychological stress just as a patient in for a major, more detailed procedure. The patient may be drowsy from the preoperative medication, but is aware of the sights and sounds around him. Reassurance is given not only verbally, but also by facial expression, manner, and a touch or warm grasp of the hand. It is important that events be explained as they happen. There is no operative procedure, even the most simple, that is without risk. The patient should never be left alone while waiting for the surgical procedure to begin. This lesson will include events, people, and procedures that may occur during the operative phase.

2-2. TERMS AND DEFINITIONS

- a. **Ablative Surgery.** Surgery performed to remove a diseased organ or other tissue.
- b. **Biopsy.** The removal and examination of tissue from the living body.
- c. **Constructive Surgery.** Surgery to repair a malformed organ or tissue.
- d. **Elective Surgery.** Surgery performed for a person's well-being, but not absolutely necessary for life.
- e. **Exploratory Surgery.** Surgery performed to confirm the extent of the pathologic process and sometimes to confirm a diagnosis.
- f. **Frozen Section.** A technique used in biopsy procedures where tissue specimens are removed from a patient with a microtome, are rapidly frozen, and then examined for a possible malignancy.
- g. **Palliative Surgery.** Surgery performed to relieve the symptoms of a disease process; for example, removal of portions of a cancerous brain tumor which will help relieve a patient of some symptoms, but will not lead to a cure because total removal is not possible.

h. **Reconstructive Surgery.** Surgery performed to repair tissues whose function or appearance is damaged; for example, plastic surgery.

Section II. SURGICAL TEAM

2-3. SURGICAL TEAM

Nowhere is a smoothly functioning team of more importance to the patient than in the operating room. Respect for others' expertise, the ability to work harmoniously, and the art of communicating effectively are necessary ingredients for a well-functioning team. Each surgical procedure will dictate the number of members on the surgical team; however, there are at least four members as a minimum. They are the surgeon, the anesthesiologist/anesthetist, the scrub nurse, and the circulating nurse (see Figure 2-1.)



Figure 2-1. Typical surgical team.

2-4. KEY MEMBERS OF THE SURGICAL TEAM

a. **Surgeon.** The surgeon is the leader of the surgical team and has the ultimate responsibility for performing the surgery in an effective and safe manner. He is dependent upon other members of the team for the patient's emotional well-being and physiologic monitoring.

b. **Anesthesiologist/Anesthetist.** The anesthesiologist/anesthetist must be constantly aware of the surgeon's actions. He must do every thing possible to ensure the safety of the patient and reduce the stress of the operation.

(1) Anesthesiologist. The anesthesiologist is a physician who is trained in the administration of anesthetics.

(2) Anesthetist. The anesthetist is a registered professional nurse who is trained to administer anesthetics.

(3) Responsibilities. The responsibilities of the anesthesiologist and the anesthetist include:

(a) Providing a smooth induction of the patient's anesthesia in order to prevent pain.

(b) Maintaining satisfactory degrees of relaxation of the patient for the duration of the surgical procedure.

(c) Continuous monitoring to the physiologic status of the patient, to include oxygen exchange, circulatory functions, systemic circulation, and vital signs.

(d) Advising the surgeon of impending complications and independently intervening as necessary.

c. **Scrub Nurse (or Scrub Assistant).**

(1) The scrub nurse or scrub assistant prepares the setup and assists the surgeon by passing instruments, sutures, etc.

(2) In the Army, the operating room specialist (91D) will often help to fill this role.

d. **Circulating Nurse.**

(1) The circulating nurse is a professional registered nurse who is free to obtain supplies, answer the anesthesiologist/anesthetist requests, deliver supplies to the sterile field, carry out the nursing care plan, etc.

- (2) The circulating nurse does not scrub or wear sterile gloves or gown.
- (3) The circulating nurse is the professional nurse liaison between scrubbed personnel and those outside of the operating room.
- (4) Responsibilities of the circulating nurse include:
 - (a) Providing for psychological comfort of the patient prior to and during induction of anesthesia.
 - (b) Making initial assessment of the patient and continued monitoring.
 - (c) Saving all discarded sponges; during surgery, participates in the sponge count to ensure that no sponge is left in the patient.
 - (d) Observing the surgical procedure and anticipating the needs for equipment, instruments, medications, and blood units.
 - (e) Preparing labels for the patient specimens for their submission to the laboratory for analysis.

Section III. THE ANESTHETIC AGENT

2-5. FACTORS THAT EFFECT THE SELECTION OF AN ANESTHETIC AGENT

a. The preoperative patient is usually interested in and concerned about the anesthesia that he will receive. He has probably heard a lot of negative talk from family, friends, and the news media about anesthesia and has usually formed an opinion as to the good or bad points of various methods in use. It is strongly advised that the anesthesiologist/anesthetist and the operating room nurse make a preoperative visit to the patient. This visit will help to allay many of the fears that exist in the patient's mind, will help in building confidence, and will enable the patient to recognize familiar faces in the operating room.

b. Before surgery, the anesthesiologist/anesthetist reviews the patient's chart, evaluates the laboratory data and diagnostic studies, verifies the surgical procedure, examines the patient, and discusses the option for anesthesia and the attendant risks. The following factors are important in selecting an anesthetic agent:

- (1) Type of surgery.
- (2) Depth and extent of anesthesia required.

- (3) Anticipated length of the procedure.
- (4) Patient's condition.
- (5) Patient's previous experiences with anesthesia.
- (6) Preferences of the anesthesiologist/anesthetist and the patient.
- (7) Available equipment.
- (8) Skill of the anesthesiologist/anesthetist.
- (9) Age of the patient.

2-6. FACTORS CONSIDERED WHEN SELECTING AN ANESTHETIC AGENT

The anesthesiologist/anesthetist must consider the following factors when selecting an anesthetic agent.

- a. Smoking and drinking habits of the patient.
- b. Presence of diseases that effect the:
 - (1) Pulmonary function/exercise tolerance.
 - (2) Hepatic function (the liver is involved in removal of most agents).
 - (3) Renal function.
 - (4) Cardiovascular function.
- c. Medication history (medications that the patient is currently taking).

2-7. CLASSIFICATION OF ANESTHETIC AGENTS

As mentioned in Lesson 1, anesthesia is a partial or complete loss of sensation, with or without loss of consciousness, as a result of a disease, an injury, or administration of a drug. Inhalation anesthesia has been classified as the most popular because of its controllability. The intake and elimination of the agent is, in large measure, affected by pulmonary ventilation. The three classifications of anesthetic agents are general, regional or block, and local.

a. **General Anesthetic.**

(1) Definition. Produces loss of consciousness and thus affects the total person.

(2) Routes of administration.

(a) Inhalation.

(b) Intravenous injection.

(c) Rectal (not used very much in today's practice).

(3) Characteristics of the ideal general anesthetic.

(a) Produces analgesia.

(b) Produces complete loss of consciousness.

(c) Provides a degree of muscle relaxation.

(d) Obtunds reflexes.

(e) Is safe and has minimal side effects.

NOTE: No single anesthetic meets all these criteria. A combination of several agents is usually used to obtain the optimal effects of each and decrease likelihood of toxicity.

(4) Uses of general anesthesia.

(a) Major head and neck surgery.

(b) Intracranial surgery.

(c) Thoracic surgery.

(d) Upper abdominal surgery.

(e) Upper and lower extremity surgery.

b. **Regional or Block Anesthetic.**

(1) Definition. Anesthetizes large regions of the body.

(2) Types.

(a) Spinal/subarachnoid. Anesthetic is injected into the cerebral spinal fluid (CSF) in the subarachnoid space; anesthetics from the umbilicus downward.

(b) Epidural block. Anesthetic is injected into the epidural space; anesthetizes from the umbilicus downward.

NOTE: The choice of using a spinal/subarachnoid anesthetic versus an epidural block is based on the factors stated in paragraph 2-5.

(c) Axillary block. Used to anesthetize an upper extremity.

c. **Local Anesthetic.**

(1) Definition. Administration of anesthetic directly into the tissues.

(2) How used. Local anesthetic can be injected intradermally or applied topically to the mucous membranes in the nasopharynx, mouth, vagina, and/or rectum.

Section IV. REASONS FOR SURGERY

2-8. GENERAL

There are many reasons for surgery and many kinds of operations. Nevertheless, surgery may be classified as elective, urgent, or emergency.

a. Elective surgery is surgery that the patient chooses to have. It is performed for his well being, but is not absolutely necessary. In elective surgery, the physician and patient agree on a time for the surgery. It could be scheduled one day or six months in advanced. For example, a mother with four school children wants to have a face-lift. She will probably schedule her surgery during the summer months when the children are out of school.

b. Urgent surgery is essential for health, such as the removal of an inflamed appendix. Urgent surgery is always essential, but not always an emergency. Another type of urgent surgery is breast surgery for a malignancy.

c. At the other extreme is emergency surgery. This surgery is unscheduled and is done immediately to save a patient's life or limb. The need for this type of surgery is sudden and unexpected. Bullet wounds, stabbings, and car accidents often require emergency surgery.

2-9. REASON FOR SURGERY VARIES

Some of the reasons why surgery is performed are given below.

- a. To obtain tissue for examination. This enables the surgeon to confirm a diagnosis.
- b. To visualize internal structures during diagnosis. This is frequently performed to determine the extent of a pathologic process and sometimes to confirm a diagnosis.
- c. To cure a disease by removing the diseased tissue or organs, such as an inflamed appendix.
- d. To repair or remove traumatized tissue and structures. This type of surgery is performed to repair a congenital malformation; for example, the repair of a harelip.
- e. To relieve symptoms by means of palliative procedures. This type of surgery is performed to relieve symptoms of a disease process. For example, an intestinal bypass would be performed to relieve the symptoms of intestinal obstruction.
- f. To improve appearance by cosmetic procedures. This type of surgery is performed to restore function or normal appearance to damaged tissues; for example, a facelift.
- g. To perform prophylactic procedures. This type of surgery is performed as a preventive measure; for example, removal of precancerous lesions such as a hairy mole.

Continue with Exercises

EXERCISES, LESSON 2

INSTRUCTIONS: Answer the following exercises by marking the letter response that best answers the exercise, by completing the incomplete statement, or by writing in the answer in the space(s) provided.

After you have completed all the exercises, turn to "Solutions to Exercises" at the end of the lesson and check your answers. For each exercise answered incorrectly, reread the material referenced with the solution.

1. What type of surgery is performed for the removal and examination of tissue from the living body?
 - a. Ablative.
 - b. Biopsy.
 - c. Elective.
 - d. Exploratory.

2. During the perioperative period, where is the most important place for a surgical team to work as a well-functioning team?

3. Which of the following members is the leader of the surgical team?
 - a. Circulating nurse.
 - b. Anesthesiologist.
 - c. Anesthetist.
 - d. Surgeon.

4. Who on the surgical team has the responsibility to advise the surgeon of impending complications and independently intervening as necessary?

5. Who on the surgical team does not scrub or wear sterile gloves or gown?

Special Instructions for Exercises 6 Through 11. Match the type of surgery in Column A with the appropriate definition in Column B by writing the letter of the definition on the space provided to the left of the exercise number.

COLUMN A

- ___ 6. Elective
- ___ 7. Reconstructive
- ___ 8. Frozen section
- ___ 9. Palliative
- ___ 10. Exploratory
- ___ 11. Ablative

COLUMN B

- a. Surgery performed to remove a diseased organ or other tissue.
- b. Surgery performed to confirm the extent of the pathologic process and sometimes to confirm a diagnosis.
- c. Surgery performed for a person's well-being, not absolutely necessary for life.
- d. Surgery performed to relieve the symptoms of a disease process.
- e. A technique used in biopsy procedures where the specimens are removed from a patient with a microtome, are rapidly frozen, and then examined for a possible malignancy.
- f. Plastic surgery.

12. List the three classifications of anesthetic agents:

13. When the anesthesiologist/anesthetist selects an anesthetic agent, he considers the patient's smoking and drinking habits, the medication history, and the presence of diseases that effect the:

14. List the nine factors which effect the selection of an anesthetic agent.

Check Your Answers on Next Page

SOLUTIONS TO EXERCISES, LESSON 2

1. b (para 2-2b)
2. Operating room (para 2-3)
3. d (para 2-4a)
4. Anesthesiologist/anesthetist (para 2-4b(3)(d))
5. Circulating nurse (para 2-4d(2))
6. c (para 2-2d)
7. f (para 2-2h)
8. e (para 2-2f)
9. d (para 2-2g)
10. b (para 2-2e)
11. a (para 2-2a)
12. General
Regional or block
Local (para 2-7)
13. Pulmonary function/exercise tolerance
Hepatic function
Renal function
Cardiovascular function (para 2-6b)
14. Type of surgery.
Depth and extent of anesthesia required.
Anticipated length of the procedure.
Patient's condition.
Patient's previous experiences with anesthesia.
Preferences of the anesthesiologist/anesthetist and the patient.
Available equipment.
Skill of the anesthesiologist/anesthetist.
Age of the patient. (para 2-5b)

End of Lesson 2

LESSON ASSIGNMENT

LESSON 3

Recovery Room Care of the Surgical Patient.

TEXT ASSIGNMENT

Paragraphs 3-1 through 3-7.

LESSON OBJECTIVES

After completing this lesson, you should be able:

- 3-1. Identify key terms related to the recovery room patient care.
- 3-2. Identify facts related to the recovery room.
- 3-3. Identify complications that should be prevented in the recovery room.
- 3-4. Identify facts related to respiratory distress.
- 3-5. Identify nursing implications related to the prevention of respiratory distress.
- 3-6. Identify facts related to hypovolemic shock.
- 3-7. Identify nursing implications related to the detection of pending hypovolemic shock.
- 3-8. Identify nursing implications related to the general care of a patient in the recovery room.

SUGGESTION

After completing the assignment, complete the exercises at the end of the lesson. These exercises will help you to achieve the lesson objectives.

LESSON 3

RECOVERY ROOM CARE OF THE SURGICAL PATIENT

Section I. INTRODUCTION

3-1. GENERAL

The recovery room, which is generally located near the operating room, has accommodations for a group of surgical patients who are under the continuous surveillance of highly skilled personnel. These patients are taken to the recovery room after surgery. There, the nurses check on the patient's condition continuously. The majority of the recovery room nurse's time is spent at the bedside rendering direct patient care. The observation of a patient cannot be completed from any other location. When the patient has fully recovered from the anesthesia and there is no evidence of complications, he is prepared to return to the nursing unit. This lesson will include the knowledge and skills required by the practical nurse to care for a surgical patient in the recovery room.

3-2. TERMS AND DEFINITIONS

- a. **Airway.** A passageway through which air normally circulates. A device that is inserted through the patient's mouth to maintain the patency of an air passage such as the trachea.
- b. **Anoxia.** A reduction in, or lack of, oxygen.
- c. **Coma.** A state of being unconscious or unresponsive to stimuli.
- d. **Conscious.** A state of being awake, responsive, and alert.
- e. **Disoriented.** A state of being confused; lack of response or inappropriate response to stimuli.
- f. **Dyspnea.** Difficult and labored breathing in which the patient has a persistent unsatisfied need for air and feels distressed.
- g. **Embolism.** The obstruction of a blood vessel by a foreign substance due to an air bubble, fat globule, or purulent matter or blood clot.
- h. **Embolus.** An embolism floating in the blood stream.
- i. **Hypoventilation.** A state in which there is a decreased or reduced volume of air taken into the lungs.

- j. **Hypoxemia.** Low oxygen content in the blood.
- k. **Hypoxia.** A decrease on the supply of oxygen to cells of the body.
- l. **Lethargic.** A condition of drowsiness or indifference.
- m. **Pallor.** The absence of the skin coloration or paleness.
- n. **Semiconscious.** A state of being able to respond to physiological stimuli, but capable only of reduced response to mental stimuli.
- o. **Suction.** The act of sucking up (or drawing up) by reducing air pressure and creating a partial vacuum.
- p. **Unconscious.** A state of being unaware and unresponsive to all stimuli.

3-3. FACTS ABOUT THE RECOVERY ROOM

- a. The recovery room is sometimes referred to as the postanesthetic room (PR) or anesthetic room (AR). It is a special nursing unit that accommodates a group of patients who have just undergone major or minor surgery.
- b. The purpose of a recovery room is to provide direct and continuous patient observation during emergence from general or regional anesthesia.
- c. The recovery room and surgical intensive care unit are used mainly for the same general purpose; that is, to accommodate a group of patients who have undergone surgery and need close observation and prompt care in the event of sudden complications. However, there is a difference between the two.
 - (1) Recovery room. The recovery room generally supports patients for a few hours until they have recovered from the anesthesia.
 - (2) Surgical intensive care unit. The surgical intensive care unit supports patients for a prolonged stay. This stay can be from 24 hours to months (in the worst cases). Additionally, this unit recovers patients from anesthesia after hours when the recovery room is closed.
- d. The practical nurse responsibility for the care of a patient in the recovery room is to prevent complications, detect early complications, relieve patient's discomfort, support patients through their state of dependence to independence, and closely monitor the patient's condition.
- e. The recovery room (see Figure 3-1) should be quiet, clean, and free of unnecessary equipment. This room should have:

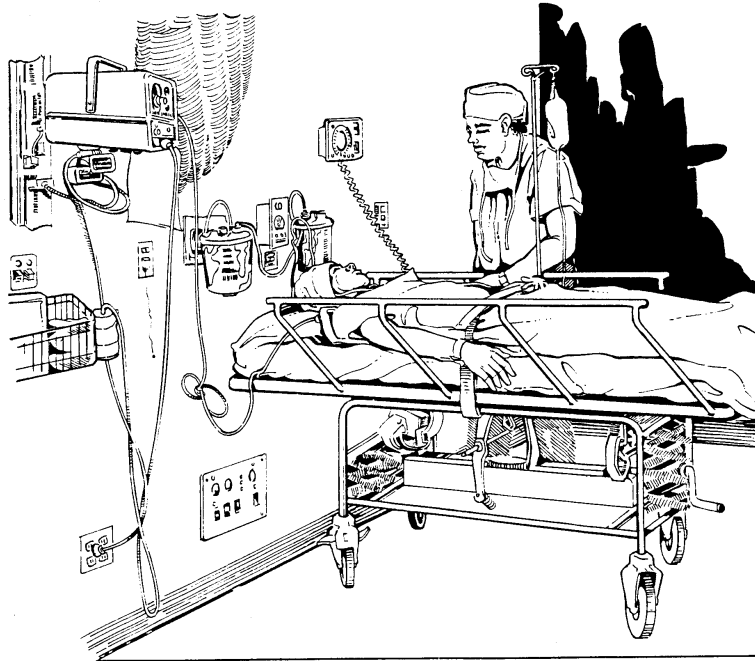

Figure 3-1. Typical recovery room.

- (1) Walls and ceiling painted in soft pleasing colors.
- (2) Indirect lighting.
- (3) Sound proof ceiling.
- (4) Equipment that controls or eliminates noises.
- (5) Isolated quarters for noisy patients.

Section II. COMPLICATIONS IN THE RECOVERY ROOM

3-4. COMPLICATIONS TO BE PREVENTED FOR THE SURGICAL PATIENT IN THE RECOVERY ROOM

The first hours after surgery require alert attention to prevent occurrence of complications that may happen while the patient is in the recovery room. Each nurse will be able to relate to the complications that are respiratory distress and hypovolemic shock.

a. **Facts Concerning Respiratory Distress.**

(1) Respiratory distress is caused by laryngospasms (a complication that may happen after the patient's endotracheal tube is removed by the anesthetist or anesthesiologist), by aspiration of vomitus, or by preoperative medications. Some preoperative medications can depress respirations, especially morphine.

(2) If the patient's breathing is obstructed because his tongue has fallen back and has obstructed the nasopharynx, the lower jaw is pulled forward and an oropharyngeal airway is inserted (see Figure 3-2).

(3) The airway is left in place until the patient is conscious. The airway prevents the tongue of the unconscious patient from blocking the air passages.

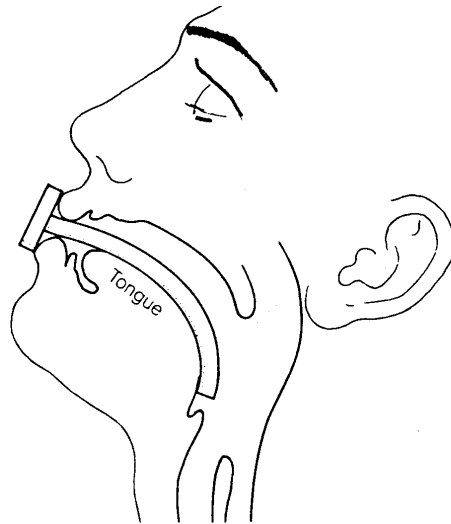

Figure 3-2. An oropharyngeal airway in place.

b. **Nursing Implications to Prevent Respiratory Distress.**

- (1) Monitor respiratory status as ordered.
- (2) Report labored and shallow or rapid respirations to the Charge Nurse.
- (3) Maintain patent airway either with oropharyngeal airway in place or removed.
- (4) Suction the patient via nose and/or orally as ordered.
- (5) Maintain the patient's position to facilitate lung expansion, usually the Fowler's position (see Figure 3-3).

(6) Administer oxygen as ordered.

(7) Maintain patient's position to prevent aspiration of vomitus (see Figure 3-4).

(a) Position the patient's head on one side and place an emesis basin under the cheek.

(b) Use tissues to wipe vomitus from the nose or mouth in order to avoid possible aspiration of the vomitus into the lungs.

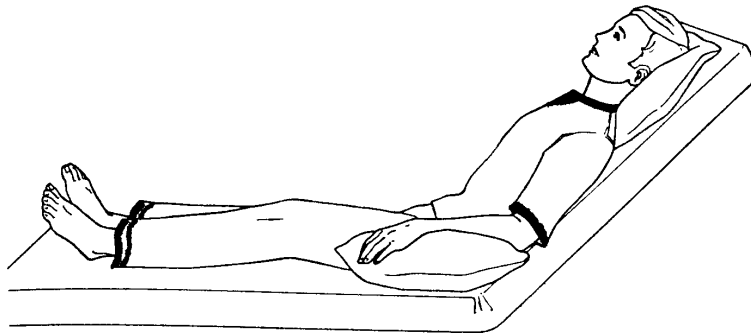

Figure 3-3. Patient in Fowler's position.



Figure 3-4. Care of patient vomiting.

c. **Facts About Hypovolemic Shock.** Hemorrhage secondary to surgery, which may be internal or external, may cause hypovolemic shock. The loss of blood or fluid volume does not have to be rapid or in copious amounts to cause shock.

d. **Nursing Implications for the Early Detection of Pending Hypovolemic Shock.**

(1) Inspect the surgical dressing and report bleeding to the Charge Nurse.

(2) If the patient has a large dressing in place, always check under the patient because the blood may drain down the sides and pool under the patient. There may be no evidence of bleeding on the top of the dressing.

(3) Reinforce the original dressing after indicating outline of blood perimeter stain on original dressing.

(4) Report to the Charge Nurse the color and amount of blood. Bright red blood indicates fresh bleeding; brownish blood indicates bleeding that is not fresh.

(5) Record all of the above events in the Nursing Notes.

(6) Monitor vital signs as ordered and report:

(a) Fall in blood pressure.

(b) Rapid, weak pulse.

(c) Restlessness.

(d) Cool, moist skin.

(7) Administer narcotics only after checking doctor's orders and consulting with the Charge Nurse. Narcotics may precipitate shock in patients in whom shock is imminent.

(8) Administer fluids to replace volume as ordered by the physician. Fluids include whole blood products, plasma expanders, and IV fluids.

3-5. GENERAL NURSING IMPLICATIONS FOR THE CARE OF A PATIENT

Nursing interventions immediately after surgery are carried out by the recovery room nurses. These nurses have special skills to care for a patient recovering from anesthesia and surgery. Their main goals are to make sure the patient is comfortable and safe while in the recovery room. The nurses will:

a. Maintain proper functioning of drains, tubes, and intravenous fluids.

b. Prevent kinking or clogging that interferes with adequate drainage of catheters and drainage tubes.

c. Encourage and assist the patient to cough, to turn frequently, and to take deep breaths several times each hour (see Lesson 1, paras 1-5a(1), (2), (3)).

d. Monitor the patient's intake and output accurately, including all IVs, blood products, urine, emesis, NG tube drainage, etc. (refer to Lesson 4, para 4-13b).

e. Implement safety measures to protect dependent and lethargic patients. These safety measures are given below.

(1) Keep siderails in the high position at all times (see Figure 3-5).

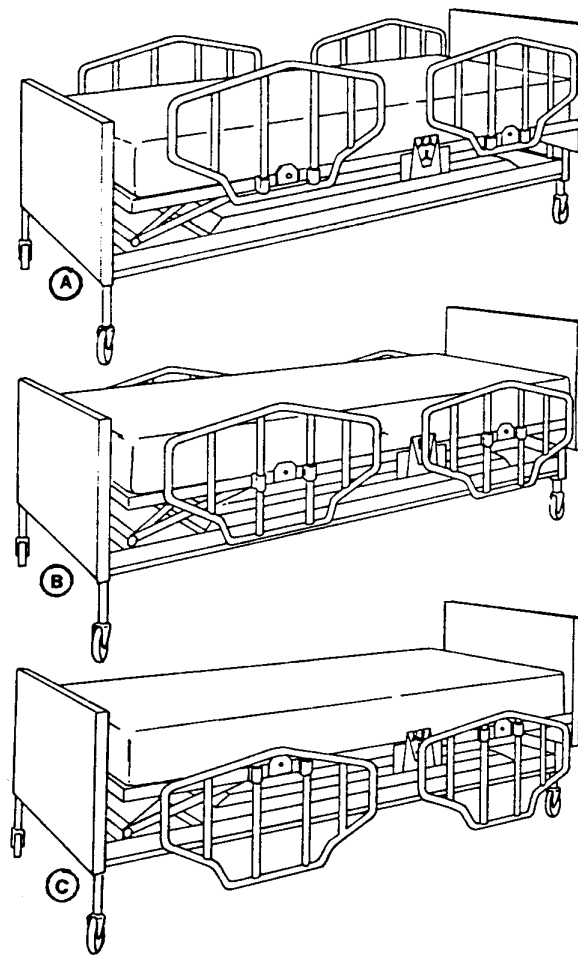

Figure 3-5. Position of the siderails. **A.** High position. **B.** Intermediate position. **C.** Low position

(2) Keep the patient warm and comfortable.

(3) If call bells are in the wall unit, teach the patient how to use them (if he is alert). Keep them readily available for the patient.

(4) Position the patient so that he is not resting on his tubes and thus preventing future skin breakdown.

(5) No head pillow is used for the unconscious patient or for 8 hours following spinal anesthesia.

(6) The patient's head is turned to one side when the patient is in the supine position so that secretions can drain from the mouth, and the tongue cannot fall back into the throat to block the air passages.

f. Prevent nosocomial infections by washing your hands before and after working with each patient. Maintain aseptic technique for incisional wound care and turn the patient frequently to prevent respiratory infections.

g. Observe for and report any feeling/movement of the patient if he has had a spinal anesthetic.

(1) Spinal anesthesia wears off slowly.

(2) Observe for spontaneous movements as recovery time goes by.

(3) Movement usually returns before feelings and is first observed in the patient's toes and then moves up the legs.

(4) As anesthesia wears off, the patient will begin to have sensation often described as "pins and needles."

(5) Keep the patient in the supine position for 6 to 8 hours to prevent spinal headache.

(6) The patient may turn from side to side and prop up with pillows if the physician permits. This is done to relieve pressure from his back, but only for a few minutes at a time.

h. Observe and document the recovery room patient's level of consciousness.

(1) Specific criteria are usually used in the recovery room for categorizing the recovering patient as follows:

(a) Alert -- The patient will be able to give appropriate response to stimuli.

(b) Drowsy -- The patient is half asleep and sluggish.

(c) Stupor -- The patient is lethargic and unresponsive, unaware of surroundings.

(d) Comatose -- The patient is unconscious and unresponsive to stimuli.

(2) Engage the patient in a conversation, if possible, to observe his level of orientation.

i. Take into consideration each patient's baseline (normal) responses due to various physical factors.

(1) Hearing deficit.

(2) Inability to understand speech/speaks a foreign language.

(3) Previous physical weaknesses.

j. Provide emotional support to the patient and family.

(1) When the patient is alert, tell him about his whereabouts and that you are nearby and will help him as needed.

(2) Teach the patient using brief, simple sentences about the tasks you will be doing.

(3) Encourage conversation with the patient. This will decrease anxiety and increase his lung expansion.

(4) Reinforce information from the surgeon.

(5) Stay with the family members if they are permitted in the recovery room. Remember, they may be frightened of the environment and the way their loved one looks.

k. When the patient is cleared by the surgeon, call the receiving nursing unit and give the report. Include the following information.

- (1) Patient's name.
- (2) Type of surgery.
- (3) Update of care in the recovery room.
- (4) Mental alertness.
- (5) Time of vital signs and results.
- (6) Interaction with family in the recovery room.
- (7) Presence, type, and functioning of drainage tubes, IV, etc.
- (8) If patient has voided or not.

l. Record all of the above information on SF 510, Nursing Notes (see Figure 3-6). Transfer the patient per recovery room SOP.

Section III. SUCTIONING THE PATIENT IN THE RECOVERY ROOM

3-6. ADMINISTERING ORAL/NASAL SUCTIONING TO THE RECOVERY ROOM PATIENT

a. Oral/nasal suctioning is suctioning of the upper airway passages of the nose, mouth, and pharynx. This procedure is used to assist the patient in eliminating secretions before he has regained full consciousness and cannot spit out secretions. The catheter used should be soft and pliable. When you employ suctioning, you must make every effort to prevent the introduction of pathogens (disease causing microorganisms) into the lower airways. Normally, countless microorganisms are found in the upper respiratory tract and it is virtually impossible to maintain sterility when suctioning the nose or pharynx. Clean technique and thorough handwashing are essential for pharyngeal suctioning of the oral and nasal cavities, but aseptic technique is mandatory for deep suctioning in the tracheobronchial tree and for the intubated patient.

CLINICAL RECORD			NURSING NOTES <i>(Sign all notes)</i>		
DATE	HOUR		OBSERVATIONS <i>Include medication and treatment when indicated</i>		
	A.M.	P.M.			
			<i>Continue on reverse side</i>		

PATIENT'S IDENTIFICATION <small>(For typed or written entries give: Name—last, first middle; grade; date; hospital or medical facility)</small>	REGISTER NO.	WARD NO.
--	--------------	----------

NURSING NOTES
 Standard Form 510
 General Services Administration and
 Interagency Committee on Medical Records
 FPMR 101-11.806-8—October 1975
 510-109

Figure 3-6. SF 510, Nursing Notes.

- b. Administer an oral/nasal suctioning to the patient in the recovery room.
 - (1) Wash your hands and assemble all needed equipment as listed:
 - (a) Portable continuous suction machine or gauge to attach to the wall suction.
 - (b) Connecting tube.
 - (c) Sterile whistle-tip straight catheter (14 to 18 Fr) with a valve or Y-connector.
 - (d) Exam gloves.
 - (e) Disposable cup with tap water.
 - (f) Waste receptacle.
 - (2) Identify the patient. If the patient is conscious, explain the suctioning procedure to him and that it may stimulate the cough reflex.
 - (3) Provide for the patient's privacy.
 - (4) Observe the patient for evidence of airway obstruction due to secretions.
 - (5) Position the patient on one side in a semi-Fowler's position, if possible.
 - (a) This will facilitate airway patency and drainage of secretions.
 - (b) If unable to place the patient in a semi-Fowler's position, be sure the patient's head is turned to the side.
 - (6) Provide a clean working area. Oropharyngeal/nasopharyngeal suctioning is a clean procedure provided suctioning is limited to the oral, nasal, and/or pharyngeal areas.
 - (7) Wash your hands.
 - (8) Open the suction catheter package, attach the end to the connecting tubing from the suction machine, and place the catheter on a clean towel (see Figure 3-7).

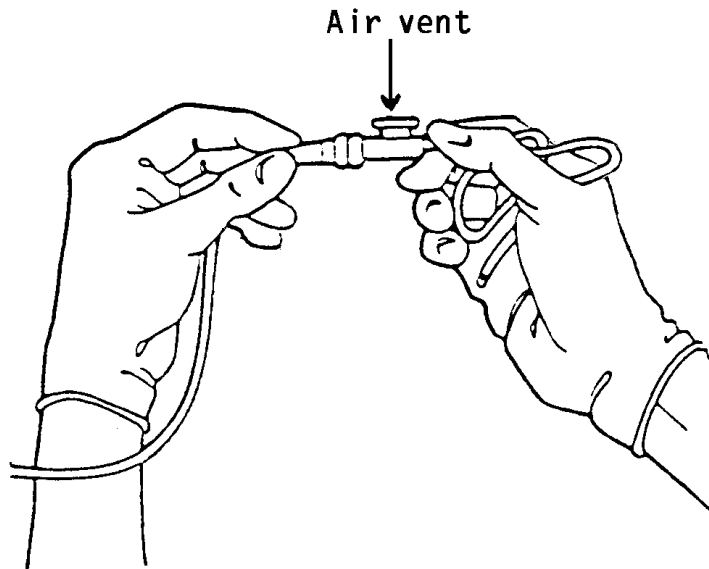

Figure 3-7. The connection of the suction catheter and the tube from the suction machine.

- (9) Put tap water in a clean paper cup.
- (10) Turn on the suction unit, and set the desired pressure according to the equipment specification or the physician's order.
- (11) Put on the exam gloves. Protective gloves should be worn during the procedure to prevent the transmission of infection.
- (12) Moisten the suction catheter tip in the cup of water to reduce friction.
- (13) Insert the catheter tip gently into the patient's nose or mouth.
 - (a) Do not apply suction during insertion.
 - (b) Do not force the catheter during insertion.
 - 1 It can cause injury to the patient's mucous membranes.
 - 2 If obstruction is encountered, call the Charge Nurse immediately for assistance.

- (14) Advance the catheter to the posterior oral/nasal pharynx.
 - (a) Stimulate a cough reflex if the patient is unable to cough effectively.
 - (b) If patient has a mouth full of vomitus or secretions, clean this area first before stimulating cough in order to avoid aspiration and introduction of infection.
- (15) Begin suctioning by placing the thumb of your nondominant hand over the catheter valve or Y-connector.
 - (a) Rotate the catheter while withdrawing to prevent irritation to the oral/nasal mucosa.
 - (b) Suction all secretions from the area.
- (16) Suction for no more than 15 seconds. Suctioning for more than 15 seconds may cause hypoxia. Allow the patient to rest for 2 to 3 minutes between catheter insertions.
- (17) Rinse the catheter in the cup of water after each insertion.
- (18) Repeat the suctioning procedure as necessary until the patient's airway is clear.
- (19) Remove your gloves and discard them and the catheter in the waste receptacle.
- (20) Reobserve the patient for evidence of airway obstruction due to secretions.
- (21) Assist the patient to a comfortable position while maintaining a patent airway.
- (22) Discard equipment or return it to the appropriate area.
 - (a) Suction collection bottles should be emptied and rinsed every 8 hours and cleaned with soap and water every 24 hours.
 - (b) Connecting tubing should be rinsed after each suctioning and changed in accordance with the local infection control policy.

(23) Wash your hands. Record the procedure and report significant observations to the Charge Nurse. You must include:

- (a) Time and frequency of the procedure.
- (b) Specific observations including color, amount, consistency, color of secretions, respirations, and breath sounds.
- (c) Patient's reaction to the procedure and position in the bed, if appropriate.
- (d) Any suction catheter or equipment changes.
- (e) All of the patient teaching done and the patient's apparent level of understanding.

3-7. ADMINISTERING ENDOTRACHEAL SUCTIONING TO THE RECOVERY ROOM PATIENT

a. Endotracheal suctioning can be accomplished through an endotracheal tube that the physician inserts through the patient's mouth and into the trachea. It can remain in place for several days and, when its cuff is inflated to provide a tight connection, it can be attached to a respirator for controlled ventilation (see Figure 3-8). The inflated cuff also aids in preventing aspiration of blood, vomitus or foreign material into the bronchus.

b. Although endotracheal suctioning is a common procedure, it is one that interferes with arterial oxygenation. The decrease in oxygen in the alveoli is directly proportional to the amount of suction and the length of time the procedure takes. The amount of oxygen in the blood drops suddenly and produces serious hypoxia. It is essential to oxygenate the patient pre- and post-suctioning.

c. Endotracheal suctioning should be done only when necessary to maintain the airway, and then it must be brief. When suctioning is unavoidable, sterile technique (aseptic) must be used.

- (1) Wash your hands and assemble all needed equipment.
 - (a) Portable continuous suction machine or gauge to attach to wall suction.

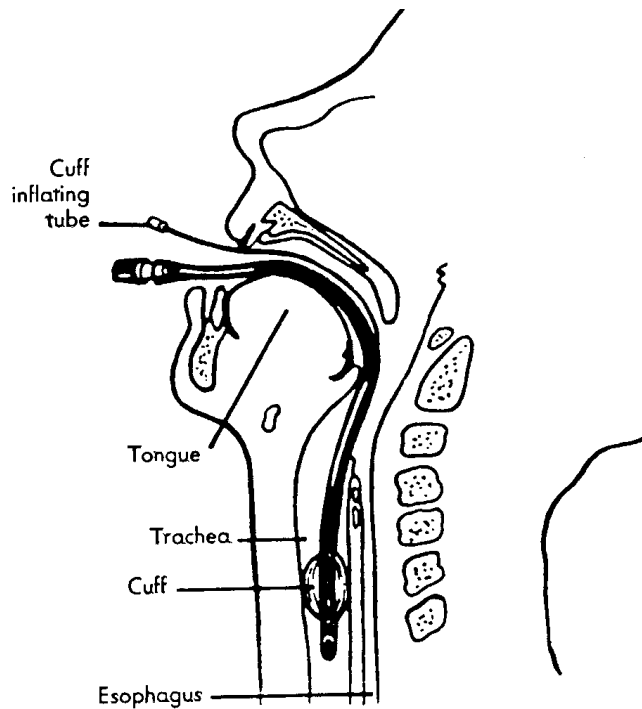

Figure 3-8. Endotracheal tube in position.

- (b) Sterile suction solution container.
 - 1 Sterile suction catheter (14 to 18 Fr).
 - 2 Sterile solution container.
 - 3 Sterile gloves.
 - (c) Sterile saline -- pour bottle.
 - (d) Oxygen flowmeter with a ventilator or manual resuscitator.
 - (e) Waste receptacle.
- (2) Identify the patient and explain the suction procedure to the patient.
 - (3) Provide the patient with privacy.
 - (4) Observe the patient for evidence of airway obstruction due to secretions.
 - (5) Position the patient in a semi-Fowler's position (see Figure 3-9).

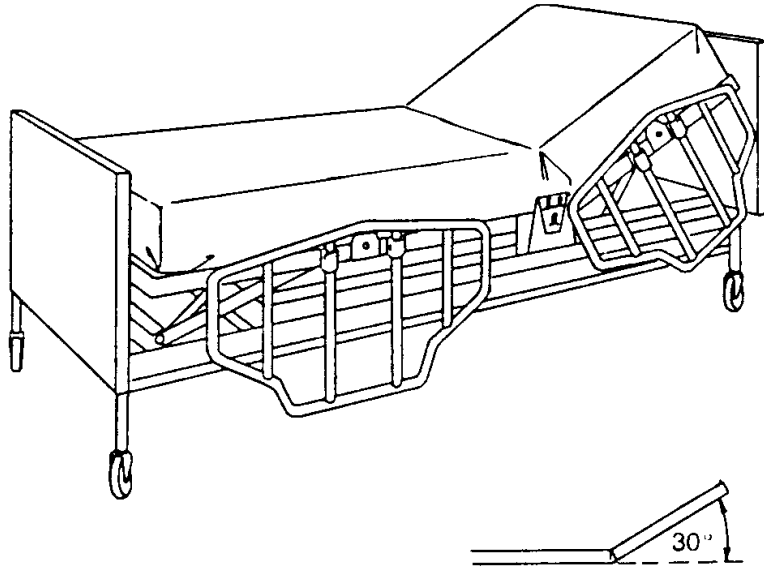

Figure 3-9. Semi-Fowler's position.

- (6) Provide a clean work area.
- (7) Wash your hands.
- (8) Open the suction kit and sterile 2 x 2-inch sponges, using the wrapper to create a sterile field.
- (9) Pour 30 to 50 cc of sterile normal saline into the sterile solution container using aseptic technique.
- (10) Turn on the suction unit and set the desired pressure according to equipment specification or the physician's order.
- (11) Put on the sterile gloves.
- (12) Attach the sterile suction catheter to the connecting tubing by holding the catheter in your dominant hand (sterile hand) and the connecting tube in your nondominant hand (nonsterile hand).
- (13) Moisten the suction catheter tip with the sterile normal saline solution.
- (14) Instruct an assistant to hyperoxygenate the patient if ordered by physician.

(a) Patients should be hyperoxygenated prior to suctioning and between suction attempts by means of a ventilator or a manual resuscitator attached to an oxygen flowmeter set at 100% oxygen.

(b) This step limits the hypoxia caused by the suctioning.

(15) Insert the sterile suction catheter gently into the endotracheal tube until resistance is felt, then pull back slightly.

(a) Suction should not be applied during catheter insertion to prevent injury to the mucous membranes.

(b) The depth of suctioning may be determined by the physician's order or by the health care facility's policy.

(16) Place the thumb of your nondominant (nonsterile) hand over the suction control.

(17) Rotate the catheter between the thumb and index fingers of your sterile hand while applying intermittent suction and withdrawing the catheter.

(a) Do not suction for longer than 10 seconds.

(b) Secretions trapped near inflated endotracheal cuffs should be removed at least every 8 hours by deflating the cuff and performing both oropharyngeal and tracheal suctioning using appropriate techniques.

(c) Reinflate the cuff to the minimum occluding volume or according to physician's order.

(18) Rinse the suction catheter in sterile saline.

(19) Instruct an assistant to hyperoxygenate the patient between suction attempts.

(20) Instill 5 cc of sterile normal saline into the trachea if ordered by the physician and, if secretion is thick, wait 5 seconds and suction the patient again.

(a) Thick secretions may be controlled by instilling 5 cc of sterile normal saline into the endotracheal tube immediately prior to suctioning.

(b) Increasing airway humidity will also assist in liquefying secretions.

(21) Repeat the suction procedure until the airway is clear, rinsing the catheter and hyperoxygenating the patient.

- (22) Perform oropharyngeal suctioning, if possible.
- (23) Shut off the suction machine.
- (24) Remove your gloves and place them in the waste receptacle.
- (25) Determine the patient's airway patency and vital signs.
- (26) Assist the patient to a comfortable position.
- (27) Discard the suction kit equipment and return all equipment to the appropriate area.
- (28) Wash your hands.
- (29) Record procedure and report significant observations to the Charge Nurse.
 - (a) Time, frequency of the procedure, and name of the person performing the procedure.
 - (b) Hyperoxygenation procedure and the equipment used.
 - (c) Specific assessment parameters including color, amount, consistency, odor of the secretions, vital signs, and breath sounds.
 - (d) Instillation of normal saline during the procedure, if possible.
 - (e) The patient's reaction to the procedure and the position in bed, if appropriate.
 - (f) The type of respiratory care equipment attached to the endotracheal tube following the procedure, as appropriate.
 - (g) Any patient teaching done and the patient's level of understanding.

Continue with Exercises

EXERCISES, LESSON 3

INSTRUCTIONS: Answer the following exercises by marking the letter response that best answers the exercise, by completing the incomplete statement, or by writing the answer in the space(s) provided.

After you have completed all the exercises, turn to "Solutions to Exercises" at the end of the lesson and check your answers. For each exercise answered incorrectly, reread the material referenced with the solution.

1. The _____ is sometimes referred to as the postanesthetic room (PR) or anesthetic room (AR). It is a special nursing unit that accommodates a group of patients who have just undergone surgery.

2. The recovery room and the surgical intensive care unit are used mainly for the same purpose. What is the primary difference between the two areas?

3. What causes hypovolemic shock? _____

4. The practical nurse has checked a patient who is bleeding. Bright red blood indicates _____ and brownish blood indicates_____.

5. What are the four categories used to describe the recovery room patient's level of consciousness?

6. After checking the doctor's orders, why is it important not to administer a narcotic to a patient who is in possible shock before consulting the Charge Nurse?

7. Lethargic refers to _____ .

8. When administering oral/nasal suctioning, begin suctioning by placing the thumb of your dominant hand over the catheter valve or connector.

a. True

b. False

9. When inserting the catheter tip in the patient's nose or mouth, why is it important not to force the catheter during insertion?

10. During endotracheal suctioning, when applying intermittent suction and withdrawing the catheter, do not suction for longer than 15 seconds.

a. True

b. False

11. When administering endotracheal suctioning, what solution is used to moisten the suction catheter tip?

Special Instructions for Exercises 12 Through 16. Match the terms in Column A with the correct definition in Column B. Place your answer in the blank space provided to the left of the item number.

COLUMN A

___ 12. Dyspnea

___ 13. Anoxia

___ 14. Airway

___ 15. Hypoxemia

___ 16. Coma

COLUMN B

- a. A passageway through which air circulates.
- b. A state of being unconscious or unresponsive to stimuli.
- c. Low oxygen content in the blood.
- d. A reduction or lack of oxygen.
- e. Difficult and labored breathing in which the patient has a persistent, unsatisfied need for air and feels distressed.

Check Your Answers on Next Page

SOLUTIONS TO EXERCISES, LESSON 3

1. Recovery room (para 3-3a)
2. The recovery room usually supports patients for a few hours until they have recovered from the anesthesia while the surgical intensive care unit supports patients for a prolonged stay (24 hours to months). (para 3-3c(1)(2))
3. Hemorrhage (para 3-4c)
4. Fresh bleeding.
Bleeding that is not fresh (para 3-4d(4))
5. Alert
Drowsy
Stupor
Comatose (paras 3-5h(1)(a), (b), (c), (d))
6. Narcotics may cause shock to occur. (para 3-4d(7))
7. A condition of drowsiness or indifference. (para 3-2i)
8. b (para 3-6b(15))
9. It can cause injury to the patient's mucous membranes. (para 3-6b(13)(b)1)
10. b (para 3-7c(17)(a))
11. Sterile normal saline solution. (para 3-7c(13))
12. e (para 3-2f)
13. d (para 3-2b)
14. a (para 3-2a)
15. c (para 3-2j)
16. b (para 3-2c)

End of Lesson 3

LESSON ASSIGNMENT

LESSON 4

Postoperative Care of the Surgical Patient.

TEXT ASSIGNMENT

Paragraphs 4-1 through 4-19.

LESSON OBJECTIVES

After completing this lesson, you should be able to:

- 4-1. Identify terms and definitions that are related to postoperative nursing.
- 4-2. Identify effects of anesthesia during the postoperative phase.
- 4-3. Identify the possible negative effects of surgery on the integumentary system.
- 4-4. Identify the types of wound healing during the postoperative phase.
- 4-5. Identify the factors that may impair wound healing.
- 4-6. Identify facts related to wound drains.
- 4-7. Identify nursing implications according to body systems as they are related to the care of a patient postoperatively.
- 4-8. Identify nursing implications that are related to the care of a postoperative patient in general.

SUGGESTION

After completing the assignment, complete the exercises at the end of the lesson. These exercises will help you to achieve the lesson objectives.

LESSON 4

POSTOPERATIVE CARE OF THE SURGICAL PATIENT

Section I. INTRODUCTION

4-1. OVERVIEW

Many of the aspects of nursing care during the recovery from the initial effects of anesthesia are carried over into the postoperative phase. In postoperative nursing, the helping and caring aspects of nursing become dramatically clear. The patient recovering from spinal anesthesia is unable to turn himself, so the nurse turns him frequently. The unconscious patient is unable to control the secretions trickling down his throat, so the nurse controls them by positioning and by suctioning. In helping the patient, the nurse is guided by the doctor's orders for postoperative treatment and therapy. However, the helping aspect of nursing is evident even as the nurse bathes perspiration from the patient's forehead or adjusts the light so that it does not shine directly in his eyes. The helplessness of the postoperative patient makes it essential that practical nurses have the skills and knowledge to help maintain the life processes, provide safety and comfort, and prevent complications. Postoperative care mainly takes place in the patient's room in the hospital.

4-2. TERMS AND DEFINITIONS

Although only a few terms and definitions are listed below, more terms and definitions will be dispersed throughout the lesson.

- a. **Atelectasis.** Collapse of the lungs.
- b. **Distention.** The state of being stretched out or bloated, as the abdominal cavity may be with gas or fluid.
- c. **Exudate.** Fluid, usually containing pus, bacteria, or dead cells.
- d. **Flatus.** Digestive tract gas that is expelled rectally (expelling gas orally is called burping or eructating).
- e. **Nasogastric Tube.** A rubber or plastic tube that is inserted through the nose (naso) and extending into the stomach (gastric).
- f. **Peristalsis.** The involuntary, wavelike motion of the digestive tract that moves food through the alimentary canal.

Section II. EFFECTS OF ANESTHESIA ON MAJOR BODY SYSTEMS

4-3. GENERAL

The physiological needs of the postoperative surgical patient are of paramount importance. Once these needs are met, his psychological and social needs can be met. The effects of anesthesia tend to last well into the postoperative phase and affect the respiratory, cardiovascular, urinary, and gastrointestinal systems.

4-4. RESPIRATORY SYSTEM

Anesthesia can cause a patient's pulmonary efficiency to decrease, thereby causing an increase in the probability of postoperative pneumonia. We all must breathe and take in sufficient oxygen in order to live. Respiratory function, or breathing, is often compromised in the surgical patient. The combination of drugs given to produce anesthesia or to reduce pain, as well as the body's response to the trauma of surgery itself, will affect the respiratory function.

4-5. CARDIOVASCULAR SYSTEM

Certain anesthetic agents can increase the probability of cardiac problems and postoperative hypotension. Common circulatory problems include hemorrhage and shock, cardiac arrest, and postoperative hypotension. Disruption of sutures and insecure ligation of blood vessels can cause hemorrhage. Shock occurs as a result of hemorrhage or cardiac insufficiency.

4-6. URINARY SYSTEM

Anesthesia can cause urinary retention. This is not an uncommon complication since anesthesia temporarily depresses urinary bladder tone. A decrease in fluid intake can lead to dehydration and infection.

4-7. GASTROINTESTINAL SYSTEM

Anesthesia slows or stops the peristaltic action of the intestine, which results in constipation. Nausea and vomiting may cause fluid imbalance. Abdominal distention/flatus may also be present.

Section III. EFFECTS OF SURGERY ON THE INTEGUMENTARY SYSTEM

4-8. GENERAL

When wounds occur, a variety of effects may result, such as immediate loss of all or part of organ functioning, sympathetic stress response, hemorrhage and blood clotting, bacterial contamination, and death of cells. Careful asepsis is the most important factor in keeping these effects to a minimum and promoting the successful care of wounds.

4-9. POSSIBLE NEGATIVE EFFECTS

a. **Wound Infection.** The first sign of wound infection is increased pain in the incision. The incision shows signs of infection by becoming reddened, warm, and swollen and by draining pus-like material. If a patient develops a wound infection, it is important to prevent it from spreading to other patients.

b. **Wound Separations.** This is the breaking apart of the edges of the incision. The causes of wound separation are malnutrition (which interferes with the normal healing process), defective suturing, infection, and excessive strain on the wound from retching, coughing, etc. Dehiscence and evisceration are two types of wound separations (see Figure 4-1).

(1) Dehiscence. This is the separation (opening) of the wound edges without the protrusion of organs. Small openings are not unusual and may be closed or supported with sterile tape. The openings always need to be supported and the wound observed regularly for further openings.

(2) Evisceration. This is the separation of the wound edges with the protrusion of organs. This rarely happens, but it is a serious complication when it does happen. The patient is usually taken to surgery immediately for resuturing.

4-10. TYPES OF WOUND HEALING

One of the most fundamental and marvelous defensive properties of living organisms is the power to heal wounds. The reaction of tissues to a surgical incision differs only in degree from that caused by a laceration (usually occurring in accidents). There are always bacteria on the skin that are carried into deeper tissues, even when the wound is a surgical incision. Clean wound healing is an intricate, exact biological process. The two types of wound healing discussed in this subcourse are primary and secondary.

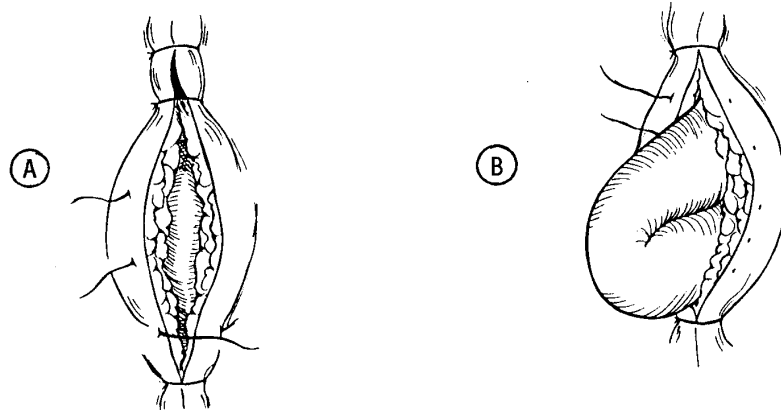

Figure 4-1. Wound separations. **A.** Dehiscence. **B.** Evisceration.

a. **Primary.** This is a form of connective tissue repair that involves the proliferation of fibroblasts and capillary buds and the subsequent laying down of collagen to produce a scar.

b. **Secondary.** This is healing of an open wound where there has been a significant loss of tissue. The defect must be filled by a slow buildup of new connective tissue. This process results in a large scar formation.

4-11. FACTORS WHICH MAY IMPAIR WOUND HEALING

The following factors may impair wound healing.

- a. Inadequate nutrition.
- b. Hypoproteinemia and vitamin C deficiency.
- c. Anemia.
- d. Diminished blood supply to the area.
- e. Steroid administration (cortisone inhibits subsequent fibroplasia and collagen formation).
- f. Obesity.
- g. Diabetes mellitus.
- h. Debilitating diseases, such as cancer.
- i. Infection.

4-12. FACTS ABOUT WOUND DRAINS

a. The technique of using drains, tubes, and catheters at the wound site may be necessary to promote healing by permitting fluid to be removed from the surgical site. This technique is often used to drain abscesses and intestinal contents when leakage may occur.

b. The Penrose drain is the most common type of drainage system used. It is made of soft rubber and causes little tissue reaction. It is sutured to the skin and a safety pin is placed externally to maintain its position. The Penrose drain acts by drawing any pus or fluid along its surfaces through a stab wound adjacent to the main incision. See Figure 4-2 for a Penrose drain.

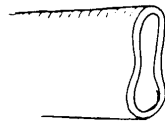

Penrose tube

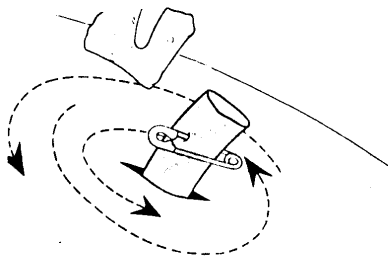

Cleaning around drain site.

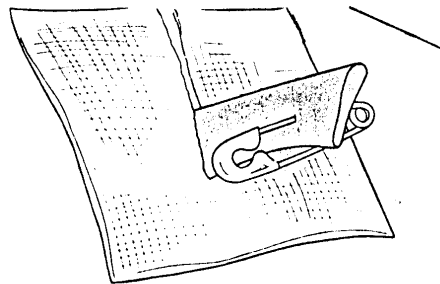

Partially split gauze placed around a Penrose drain.

Figure 4-2. Penrose drain.

Section IV. NURSING IMPLICATIONS BY BODY SYSTEMS OF A POSTOPERATIVE PATIENT

4-13. RESPIRATORY SYSTEM

Postoperative nursing intervention to meet respiratory needs is chiefly designed to prevent respiratory complication. Nursing actions include checking the patient's respiratory rate, depth, and rhythm as ordered or according to local policy or whenever vital signs are taken. Being alert to signs of respiratory problems cannot be over emphasized. Measures for encouraging lung expansion and exchange of gas are given below.

- a. Reteach the patient coughing and deep breathing exercises (refer to Lesson 1, paras 1-5a(2) and (3)). Coughing is encouraged to dislodge mucous plugs. Deep breathing helps to maximize voluntary lung expansion. Record the procedure and report significant observations to the Charge Nurse. Include the time of procedure, sputum (if present -- color, odor, amount), and patient's tolerance.
- b. Turn the patient as ordered (refer to Lesson 1, para 1-5a(1)). Turning the patient allows alternating maximum expansion of the uppermost lung.
- c. Ambulate the patient as ordered. If the patient cannot ambulate, periodically assist him to a sitting position in bed if allowed. This position permits the greatest lung expansion. Ambulation promotes deep breathing.
- d. Position the patient in a Fowler's position to facilitate lung expansion, if permitted.

4-14. CARDIOVASCULAR SYSTEM

Nursing measures to meet the patient's circulatory needs are provided to prevent thrombophlebitis.

- a. Reteach lower extremity exercises while the patient is on bedrest (refer to Lesson 1, para 1-5a(4)).
- b. Ambulate the patient, as ordered.
 - (1) Provide physical support for first attempts.
 - (2) Have patient dangle feet at bedside before ambulation.
 - (3) Monitor patient's blood pressure while he dangles.

NOTE: Do not ambulate patient if he is hypotensive when dangling. Report this event to the Charge Nurse.

4-15. URINARY SYSTEM

As previously mentioned, anesthetics temporarily depress urinary bladder tone. Urinary bladder tone usually returns within six to eight hours after surgery. The length of time a patient may be permitted to go without voiding after surgery varies considerably with the type of surgery performed. However, in the mean time, nursing responsibilities in relation to urinary elimination are those listed below.

a. Report to the Charge Nurse if the patient without a Foley catheter has not voided within eight hours of return to ward from the recovery room.

(1) Patients who have had abdominal surgery, particularly if in the lower abdominal and pelvic regions, often have difficulty voiding after surgery.

(2) Operative trauma in the region near the bladder may temporarily decrease the sensation of needing to void (urinate).

(3) The fear of pain may cause tenseness and difficulty in voiding.

b. Palpate patient's bladder for distention and assess patient's response.

(1) The patient will tell you if he has to void (he will feel a sense of fullness and urgency).

(2) Report this event to the Charge Nurse.

c. Assist the patient to void.

(1) Position the patient comfortably on bedpan, with urinal, or in bathroom.

(2) Provide the patient with privacy.

d. Measure and record the patient's urinary output.

e. Notify the Charge Nurse if less than 30 cc of urine is voided during first experience after surgery.

f. Report to the Charge Nurse if the patient complains of bleeding when voiding or urine shows blood.

g. Follow ward infection control SOP for care of a patient with a Foley catheter.

4-16. GASTROINTESTINAL SYSTEM

a. **Normal Function of the Gastrointestinal System.** Regaining normal function of the gastrointestinal system as soon as possible is very important. The following nursing implications also apply to the patient who has had abdominal surgery.

(1) Report to the Charge Nurse if the patient complains of abdominal distention.

(2) Ask the patient if he has "passed gas" within 24 hours of return to the ward from the recovery room.

(3) Auscultate for bowel sounds and report assessment to the Charge Nurse.

(4) Provide the patient with a quiet environment in a private bathroom so he feels comfortable expelling flatus.

(5) Encourage the patient to take warm or hot liquids and solids rather than cold, if he is not NPO. Warm or hot liquids help to reduce distention.

(6) Ambulate the patient to assist peristalsis.

(7) Administer medications or enema as ordered by the physician if nursing measures are not effective in relieving abdominal distention. Both treatments will facilitate peristalsis and relieve distention.

(8) Tell the patient to report his first postoperative bowel movement to you.

(9) Record patient's bowel movement on Intake and Output (I & O) Work Sheet.

(10) Document nursing measures and results in the Nurse's Notes.

NOTE: Last measures to reduce abdominal distention may require the insertion of a nasogastric (N/G) tube or use of a rectal tube.

b. **Nasogastric Tube.** The procedures to insert a nasogastric tube to administer intestinal decompression therapy to a postoperative patient are given below.

(1) Wash your hands and assemble all needed equipment.

(a) NG (Levin) tube.

(b) Irrigating set which includes: a basin, lubricant (water-soluble), towel, solution container, irrigating syringe, and protector cap or tube plug.

(c) Tape.

(d) Tissues.

(e) Stethoscope.

(f) Glass of water and straw.

(g) Nasogastric suction apparatus (as needed).

(2) Identify and approach the patient, explain what you are going to do, and gain his cooperation.

(3) Provide for patient's privacy.

(4) Position the patient.

(a) The Fowler's position is usually assumed because it enables the tube to move by gravity down the digestive tract.

(b) Hand the emesis basin and the tissues to the patient or place the emesis basin close beside the patient's face with the tissues near the pillow.

(5) Check the airflow through the patient's nostril.

(a) Close one side of the patient's nose and check the airflow through the other.

(b) Pass the tube through the nostril with the best airflow.

(c) If changing the NG (Levin) tube, insert it in the nostril other than the one previously used to avoid further irritation of the tissue.

(6) Measure the tube for distance to be inserted.

(a) Find the target distance for inserting the tube by measuring from the tip of the nose to the tip of the ear, and then to the tip of the xiphoid process (see Figure 4-3. Mark it with a small piece of tape.

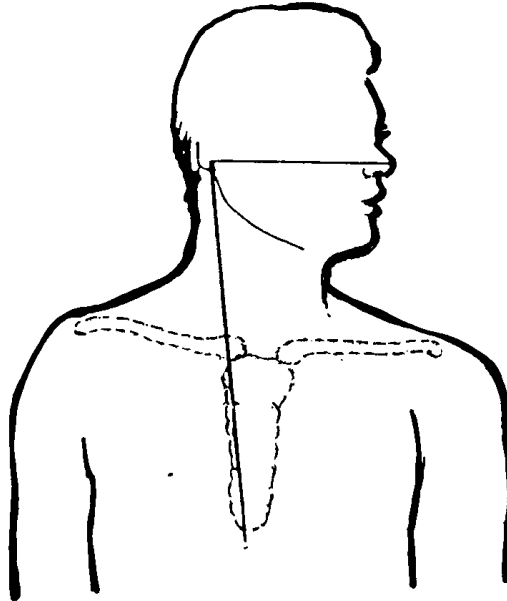

Figure 4-3. NEX -- Nose to Ear to Xiphoid.

(b) A scale (commercial) is available that measures the distance more precisely since NEX may be too long for short patients and too short for taller adults.

(c) Some tubes have approximate target marking on them.

1 One black band indicating the length of the tubing needed to reach the stomach.

2 Two bands for the pylorus.

3 Three bands for the duodenum.

(7) Lubricate the tip of the tube and insert it in the patient's nose.

(a) Aim the tube down and toward the ear.

(b) For easier insertion, use water or a water-base lubricant to moisten the tip of the tube.

(c) Do not use an oil-base lubricant. The possibility of lipoid (fat) aspirational pneumonia is to be avoided.

(d) If you encounter a severe resistance, withdraw the tube and insert it in the other nostril.

(e) Do not forcibly push it because you could injure tissues and cause bleeding.

(8) Have the patient drop his head forward and begin to swallow as the tube reaches the back of the throat.

(a) Tell the patient to bend his head forward and (if permitted) to swallow sips of water as the tube is passed down the esophagus to the stomach.

(b) Check the position of the tube as it passes down the back of the patient's throat by having the patient open his mouth. Hold down the patient's tongue with a tongue depressor.

(c) Withdraw the tube into the nose and begin again by having the patient bend head forward and swallow; restart if the tube is coiled up in his mouth.

(d) Avoid long waits (long delays can increase the patient's anxiety/discomfort). However, the patient can signal you to stop for a moment to rest, if necessary.

(9) Advance the tube each time the patient swallows or sucks air. See Figure 4-4.

(a) If permitted, continue to have the patient swallow water or ice. This helps as the tube is passed.

(b) The esophageal peristalsis and the fact that you work in a reassuring manner will help the patient tolerate the procedure.

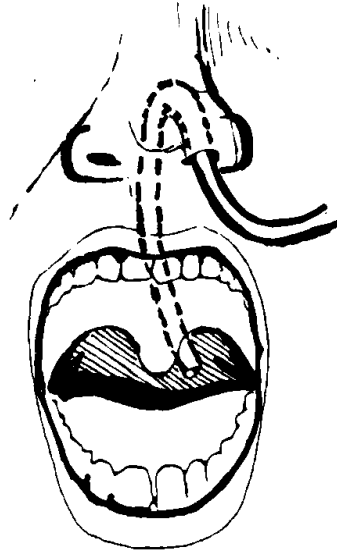

Figure 4-4. Advancing NG tube.

(10) Check the placement of the tube.

(a) When the target point on the tube has reached the nose, the tube should be in the stomach.

(b) Verify placement by one of the following methods:

1 The return of gastric juices is an obvious sign. Use the irrigating syringe to pull back using gentle suction and aspirate the stomach contents. If none are obtained, turn the patient onto his left side, insert the tube another one or two inches, and try again.

2 Inject 10 to 20 ml of air into the tube with the irrigating syringe and listen with the stethoscope placed to the left of the xiphoid. The air will make a swishing sound as it enters the stomach. The patient may belch if the tube is in the esophagus.

(c) If the patient has dyspnea, coughing, or cyanosis or is unable to talk or hum, the tube is in the trachea and must be immediately removed and reinserted.

(11) Tape the tube securely to the face, avoiding pressure caused by the tube against the nasal tissues (see Figure 4-5).

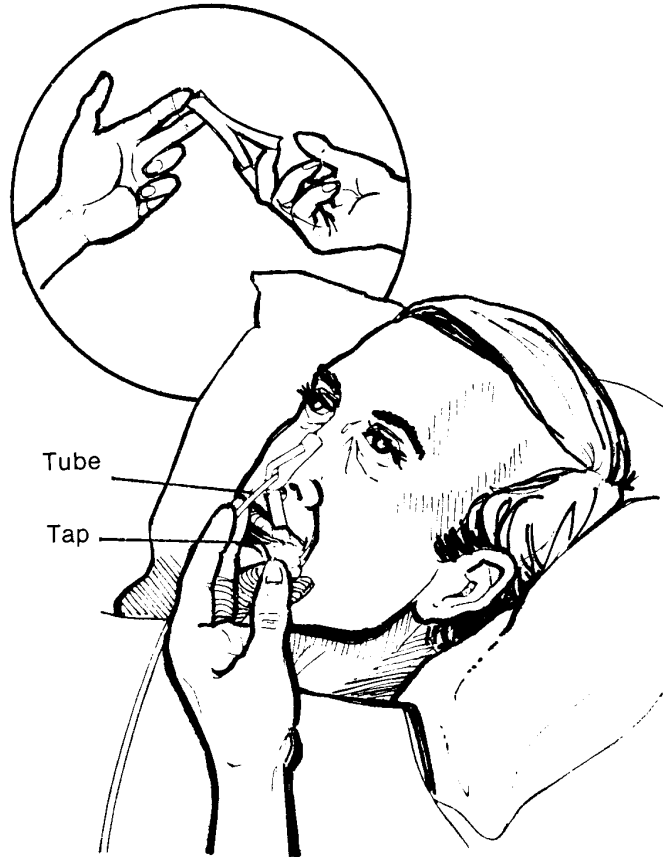

Figure 4-5. Applying tape to secure NG tube.

- (12) As ordered, attach the free end of the tube to the suction machine.
 - (a) Make sure the machine is plugged in and turned on low pressure.
 - (b) If suction has not been ordered, clamp, plug, or cover the end of the NG (Levin) tube so that it will not leak gastric contents.
 - (c) When the patient is allowed out of bed, loosely loop the tubing in a circle, secure it with adhesive tape, and pin to the patient's gown.
 - (d) This will help prevent pulling that would be uncomfortable to the patient as well as tube dislodgement.
- (13) Provide for the patient's comfort.
- (14) Remove used articles and leave bedside unit neat and tidy.

(15) Record procedure and report significant observations to the Charge Nurse.

c. **Rectal Tube.** The procedures for using a rectal tube to administer intestinal decompression therapy to a postoperative patient are as follow.

- (1) Wash hands and assemble all equipment.
 - (a) Rectal tube with attached vented bag (22 to 24 Fr).
 - (b) Water-soluble lubricant.
 - (c) Chux^R.
 - (d) Exam gloves.
 - (e) Wash cloth and towel.
- (2) Verify the physician's order.
- (3) Identify and approach the patient, explain what you are going to do, and gain his cooperation.
- (4) Provide for patient's privacy.
- (5) Assist the patient to a left side-lying position with knees slightly flexed.
- (6) Place the Chux^R under the patient's buttocks.
- (7) Cover the patient with a sheet.
- (8) Wash your hands.
- (9) Put on exam gloves.
- (10) Lubricate the tip of the rectal tube with water-soluble lubricant.
- (11) Separate the patient's buttocks and gently insert the tip of the tube 3 to 5 inches into the rectum. See Figure 4-6. **DO NOT FORCE THE TUBE.**

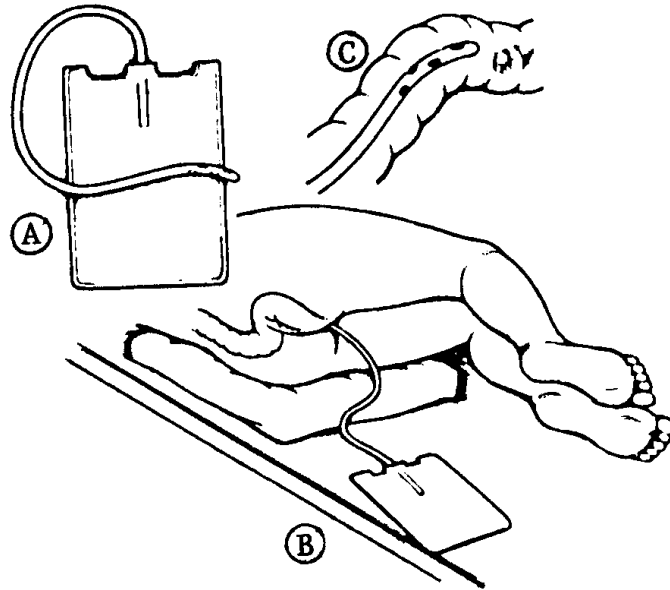

Figure 4-6. Rectal tube inserted. **A.** Rectal tube attached to plastic bag. **B.** Tube in place. **C.** Enlargement of lower colon showing gas bubbles that will be tapped by rectal tube.

- (12) Remove the exam gloves.
- (13) Leave the tube in place for 20 minutes or as ordered by the physician.
- (14) Remove the tube after the prescribed time.
- (15) Wash and dry the anal area.
- (16) Position the patient comfortably.
- (17) Observe the bag for inflation.
- (18) Discard equipment or return it to the appropriate location.
- (19) Wash your hands.
- (20) Record procedures and report significant observations to the Charge Nurse.
 - (a) Time the rectal tube was inserted and removed.
 - (b) The patient's reaction to the procedure; if he feels less full.
 - (c) All patient teaching done and the patient's apparent level of understanding.

4-17. INTEGUMENTARY SYSTEM

Being knowledgeable of the location of every wound and drainage tube is very important. The practical nurse must practice aseptic techniques in collecting specimens, avoiding accidental contamination of the specimen, and the spread of infection to others.

a. Procedures for Collecting/Submitting a Wound Culture Specimen From a Postoperative Patient.

- (1) Wash hands and assemble all equipment.
 - (a) Antiseptic swabs.
 - (b) Sterile culturette tube or sterile applicator with a culture medium tube.
 - (c) Exam gloves.
 - (d) Sterile gloves.
 - (e) Sterile dressings, as appropriate.
 - (f) Waste receptacle.
- (2) Verify the physician's order.
- (3) Identify and approach the patient, explain what you are going to do, and gain his cooperation.
- (4) Provide adequate lighting and for patient's privacy.
- (5) Wash your hands.
- (6) Position and drape the patient as indicated for the site of the specimen collection.
- (7) Put on exam gloves.
- (8) Remove patient's wound dressings, if appropriate, and discard.
- (9) Remove exam gloves.
- (10) Open sterile supplies using aseptic technique.
- (11) Apply the sterile gloves.

(12) Cleanse the skin around the area to be cultured with antiseptic swabs to prevent contamination of the specimen by surface bacteria.

(13) Obtain the specimen. The break stick technique or the culturette method may be used.

(a) Break stick technique.

1 Remove the cap from the culture tube and hold the cap in your nondominant hand, maintaining sterility of the inside of the cap.

2 Using sterile applicator, swab the exudate from the site.

3 Insert the swab portion of the applicator into the sterile culture tube.

4 Break off the upper portion of the applicator.

5 Replace the cap on the culture tube.

(b) Culturette method.

1 Remove the cap with the sterile applicator attached from the culturette tube.

2 Swab the exudate from the site.

3 Replace the swab in the culturette tube, securing the cap.

4 Turn the culturette tube cap down.

5 Crush the ampule in the bottom of the tube by squeezing it between your index finger and thumb at midpoint.

6 Push the cap down to bring the swab into contact with the culture medium.

(14) Redress the patient's wound with the appropriate dressing, if necessary.

(15) Remove the sterile gloves.

(16) Label the specimen container.

(17) Reposition the patient comfortably.

- (18) Discard equipment or return it to the appropriate area.
- (19) Wash your hands.
- (20) Complete the laboratory request slip, if not already prepared.
- (21) Send the specimen to the laboratory immediately. The specimen can be destroyed if it is not plated to a culture medium at once.
- (22) Record procedure in patient's clinical records.

Nonmedication.

- (a) DA Form 4578, Therapeutic Documentation Care Plan --

- (b) SF 510, Nursing Notes.
 - 1 Time, site, and method of specimen collection.
 - 2 Appearance of the patient's wound site and the specimen collected.

- 3 The patient's tolerance of the procedure.
- 4 Disposition of the specimen.
- 5 All patient teaching done and the patient's apparent level of understanding.

b. **Maintain the Postoperative Patient's Wound/Nasogastric Drainage Tubes.** The nurse must connect and maintain the tubes to the ordered suction device, must avoid introduction of microorganisms into wound or drainage system, and must also avoid dislodging tubes. The procedures are as follow.

- (1) Wash hands and assemble all equipment.
 - (a) Suction unit (Hemovac, electric or wall vacuum continuous unit, or intermittent suction).
 - (b) Graduated container.
- (2) Verify physician's order.
- (3) Identify and approach the patient, explain what you are going to do, and gain his cooperation.

(4) Provide for the patient's privacy and position the patient to facilitate access to the drainage tube.

(5) Provide adequate lighting.

(6) Wash your hands.

(7) Activate the appropriate/ordered tube drainage/suction unit.

(a) Hemovac (wound drainage tube suction) (see Figure 4- 7).

1 Remove the plug cap aseptically and place the portable suction unit upright on a firm surface.

2 Compress the suction unit as flat as possible (see Figure 4-8).

3 Replace the plug cap immediately (see Figure 4-9).

4 Position the suction unit to prevent kinking of the tubes or dropping of the unit.

5 Observe the suction unit for proper compression and patency.

(b) Electric or wall vacuum continuous or intermittent wound/gastrointestinal suction unit (see Figures 4-10 and 4-11).

1 Plug the unit into an electrical outlet or attach to a wall system vacuum.

2 Connect the suction tube to the patient's drainage tube, using aseptic technique.

3 Tape the connection. Ensure that the tubing is not pulling on the drainage tube.

4 Turn the suction unit on "Low" unless specifically ordered differently.

5 Observe the suction system for proper functioning.

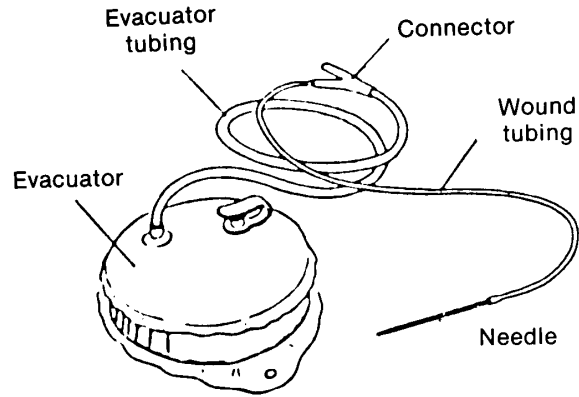

Figure 4-7. Hemovac.

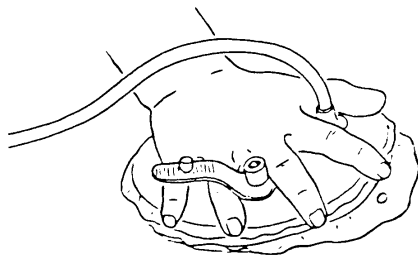

Figure 4-8. Compressing unit to form vacuum.

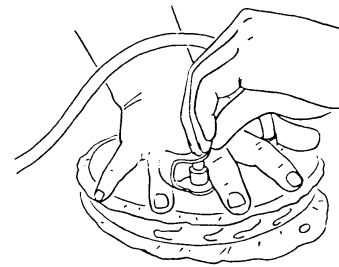

Figure 4-9. Replace plug in outlet to retain vacuum.

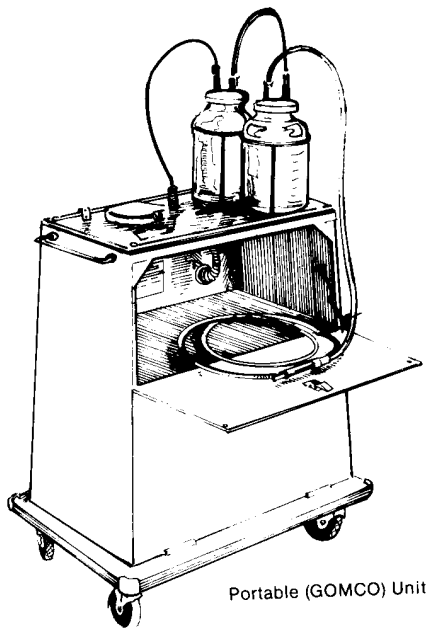

Figure 4-10. Wound/gastrointestinal suction portable unit.

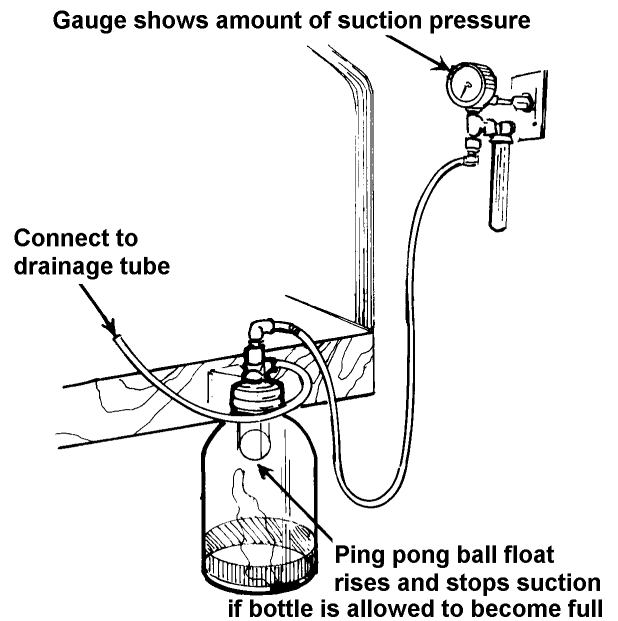

Figure 4-11. Wound/gastrointestinal suction wall unit.

(8) Empty the drainage collection device, as necessary.

(a) Hemovac.

1 Remove the plug cap, using aseptic technique.

2 Invert the suction unit over the graduated container and empty the contents (see Figure 4-12).

3 Return the unit to an upright position and reactivate the unit. Measure and read the drainage and discard.

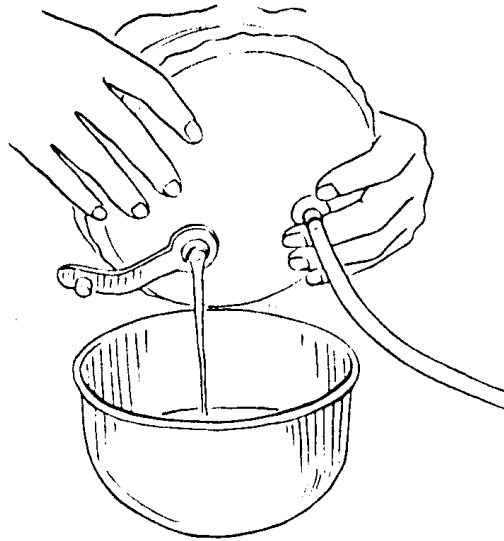

Figure 4-12. Opening outlet to remove drainage.

(b) Electric wall vacuum continuous or intermittent wound section unit.

1 Turn the suction unit off.

2 Empty the drainage bottle.

3 Measure and record the drainage and discard.

4 Reattach the drainage bottle.

5 Turn the suction unit on and observe for proper function.

(9) Discard equipment or return it to the appropriate location.

(10) Wash your hands.

Nurse. (11) Record procedure and report significant observation to the Charge

- (a) Type of wound catheter and suction.
- (b) Amount, color, characteristics, and odor of drainage.
- (c) The patient's reaction to the procedure.
- (d) Function of suction system.
- (e) Any observations of the wound area or dressing.
- (f) All patient teaching done and the patient's apparent level of understanding.

c. **Remove Sutures from a Postoperative Patient's Surgical Wound.** The nurse must avoid introduction of skin surface contaminants into wound site and interference with wound healing. He must also avoid causing unnecessary pain/discomfort for the patient.

- (1) Verify the physician's order.
- (2) Wash hands and assemble needed equipment.
 - (a) Prepackaged suture removal supplies/equipment.
 - (b) Antiseptic pledgets.
 - (c) Smooth forceps.
 - (d) Scissors
 - (e) Dressings/sterile wipes.
 - (f) Hydrogen peroxide (as required).
- (3) Identify and approach the patient, explain what you are going to do, and gain his cooperation.
- (4) Remove the patient's wound dressing to expose suture line.
- (5) Cleanse the stitch area carefully and thoroughly with hydrogen peroxide.

(6) Use hydrogen peroxide to remove dried secretions or encrustations, as necessary.

(7) Grasp the knot of each suture with a pair of smooth forceps and gently pull upward to pull stitch away from the skin (see Figure 4-13).

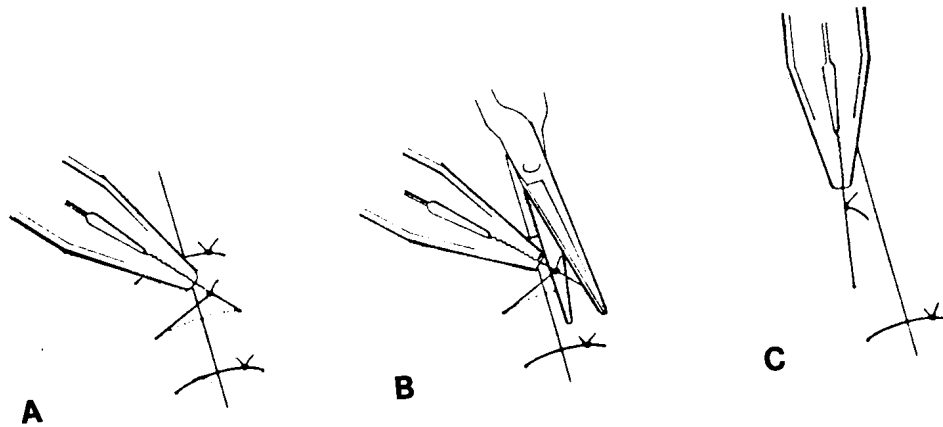

Figure 4-13 Removing suture from wound.

(8) Cut the shortened end of each stitch as close to the skin as possible and pull each stitch free from the wound.

(a) Allows the stitch to be pulled free of wound so that when stitch is removed, only that part of the stitch which is under the skin touches the subcutaneous tissues.

(b) No segment of the stitch that is on the surface of the skin should be drawn below the skin surface. That could introduce skin surface contaminants subcutaneously with risk of infection.

(c) If the suture does not pull free when cut or is embedded into healed suture line, report immediately to the Charge Nurse or to the physician for assistance.

(d) For continuous suture removal, cut the suture at each skin orifice on one side and remove suture from the opposite side. The objective is to avoid subcutaneous contamination.

(9) Pat the suture removal sites with an alcohol sponge.

(10) Reapply dressing as appropriate.

- Nurse.
- (11) Record procedure and report significant observations to the Charge Nurse.
 - (a) Wound site condition.
 - (b) Surface healing.
 - (c) Evidence of infection.
 - (d) Poor wound adhesiveness.

Section V. GENERAL NURSING IMPLICATIONS OF THE POSTOPERATIVE PATIENT

4-18. GENERAL

The length of time a patient needs to recuperate from a surgical experience depends on the patient's preoperative physical and mental preparation, the type and magnitude of the surgical procedure, and the multiple factors involved in the postoperative recuperative periods.

4-19. GENERAL POSTOPERATIVE NURSING TASKS

In helping the surgical patient to return to his maximal possible state of health, in addition to your specific duties, you must also perform the following.

- a. Monitor the patient's vital signs as ordered.
- b. Report the patient's elevated temperature and rapid/weak pulse immediately to the Charge Nurse. As mentioned before, this may be an indication to an infection.
- c. Report the patient's lowered blood pressure and increased pulse to the Charge Nurse. This may be an indication to hypovolemic shock.
- d. Administer analgesics to the patient as ordered.
- e. Apply all nursing implications related to the patient receiving analgesics (narcotic or not).
- f. Participate in nutrition therapy with the health team. You will be providing nutrition to the postoperative patient according to the patient's condition and doctor's order.

g. Apply all nursing implications related to diets -- serving, recording intake, and food tolerance.

h. Maintain and administer all IV fluids and IV sites per doctor's orders and infections control SOP.

i. Prepare the patient and family for discharge.

(1) Supply written instructions for:

(a) Wound care.

(b) Surgical/clinic appointment.

(c) Phone numbers of related clinics.

(2) Coordinate with team leader for CMS supplies needed for wound care and prescriptions for self administration.

(3) Document discharge in the Nursing Notes per ward SOP.

Continue with Exercises

EXERCISES, LESSON 4

INSTRUCTIONS: Answer the following exercises by marking the letter response that best answers the question, by completing the incomplete statement, or by writing the answer in the space(s) provided.

After you have completed all the exercises, turn to "Solutions to Exercises" at the end of the lesson and check your answers. For each exercise answered incorrectly, reread the material referenced with the solution.

1. List the major body systems that are affected by anesthesia.

2. What are the two possible negative effects of surgery on the integumentary system?

3. _____ is the separation of the wound edges without the protrusion of organs.

4. What are the two types of wound healing?

5. List four factors that may impair wound healing.

6. What is the most common type of drainage system for draining wounds?

7. Why is it important to turn a patient during the postoperative phase?

8. If regular methods do not control abdominal distension, what last measures are applied to reduce abdominal distention?

9. NEX stands for _____

10. When inserting the NG tube into the patient's nose, why is it important to NOT use an oil-base lubricant?

11. Why should long waiting periods be avoided when inserting a NG tube?

12. When should the NG tube have reached the patient's stomach?

13. What two methods may be used when collecting and submitting a wound culture?

Special Instructions for Exercises 14 Through 18. Match the terms in Column A with the correct definition in Column B. Place your answer in the blank space provided to the left of the number in Column A.

COLUMN A

COLUMN B

___ 14. Distention

a. Fluid usually containing pus, bacteria, or dead cells.

___ 15. Evisceration

b. A rubber tube that is inserted through the nose down to the stomach.

___ 16. Exudate

c. The state of being stretched out or bloated.

___ 17. Nasogastric tube

d. Gas expelled rectally.

___ 18. Flatus

e. Separations of the wound edges with the protrusion of organs.

Check Your Answers on Next Page

SOLUTIONS TO EXERCISES, LESSON 4

1. Respiratory
Cardiovascular
Urinary
Gastrointestinal (para 4-3)
2. Wound infection
Wound separations (paras 4-9a, b)
3. Dehiscence (para 4-9b(1))
4. Primary
Secondary (para 4-10)
5. Any four of the nine listed:
 - Inadequate nutrition
 - Hypoproteinemia and vitamin C deficiency
 - Anemia
 - Diminished blood supply to the area
 - Steroid administration
 - Obesity
 - Diabetes mellitus
 - Debilitating diseases like cancer
 - Infection (paras 4-11a through i)
6. Penrose drain (para 4-12b)
7. Allows for alternating maximum expansion of the uppermost lung.
(para 4-13b)
8. Insertion of a nasogastric tube.
Insertion of a rectal tube. (paras 4-16b, c)
9. Nose to ear to xiphoid (para 4-16b(6)(a), fig 4-3)
10. Lipoid (fat) aspirational pneumonia could occur. (para 4-16b(7)(c))
11. Long delays can increase a patient's anxiety/discomfort. (para 4-16b(8)(d))
12. When the target point on the tube reaches the patient's nose. (para 4-16b(10)(a))
13. Break stick technique
Culturette method (paras 4-17a(13))

14. c (para 4-2b)
15. e (para 4-9b(2))
16. a (para 4-2c)
17. b (para 4-2e)
18. d (para 4-2d)

End of Lesson 4

COMMENT SHEET

SUBCOURSE MD0915 Nursing Care of the Surgical Patient

EDITION 100

Your comments about this subcourse are valuable and aid the writers in refining the subcourse and making it more usable. Please enter your comments in the space provided. ENCLOSE THIS FORM (OR A COPY) WITH YOUR ANSWER SHEET **ONLY** IF YOU HAVE COMMENTS ABOUT THIS SUBCOURSE..

FOR A WRITTEN REPLY, WRITE A SEPARATE LETTER AND INCLUDE SOCIAL SECURITY NUMBER, RETURN ADDRESS (and e-mail address, if possible), SUBCOURSE NUMBER AND EDITION, AND PARAGRAPH/EXERCISE/EXAMINATION ITEM NUMBER.

PLEASE COMPLETE THE FOLLOWING ITEMS:

(Use the reverse side of this sheet, if necessary.)

1. List any terms that were not defined properly.

2. List any errors.

paragraph error correction

3. List any suggestions you have to improve this subcourse.

4. Student Information (optional)

Name/Rank _____

SSN _____

Address _____

E-mail Address _____

Telephone number (DSN) _____

MOS/AOC _____

PRIVACY ACT STATEMENT (AUTHORITY: 10USC3012(B) AND (G))

PURPOSE: To provide Army Correspondence Course Program students a means to submit inquiries and comments.

USES: To locate and make necessary change to student records.

DISCLOSURE: VOLUNTARY. Failure to submit SSN will prevent subcourse authors at service school from accessing student records and responding to inquiries requiring such follow-ups.